

Numero Verde  
**800020343**



FMN Martinelli S.p.A.  
25070 Casto (BS) Italia - località Piani di Mura 2  
Tel. +39-0365-899113 r.a. Fax +39-0365-899118

COMPANY  
WITH QUALITY SYSTEM  
CERTIFIED BY DNV  
ISO 9001/2000

CATALOGO GENERALE MARTINELLI ED. 2008 REV. 00

H A N D L E S   W I T H   C A R E



made in italy



[www.fmmartinelli.it](http://www.fmmartinelli.it)



<b>Maniglie - Door handles</b>	<b>25</b>	Posthorn	153	<b>Battenti - Knockers</b>	<b>175</b>
Airone	50	Prelude	140	America	177
Appia	26	Rosy	132	Anello	177
Arcadia	70	Round	62	Barocco	176
Beauty	148	Sabina	112	Esagono	176
Beverly	56	Siria	153	Georgian	177
Boomerang	64	Techna	72	Leone	176
Bruxelles	150	Tesa	74	Victorian	177
Carola	106	Tipo	76		
Classic	86	Venere	152		
Classic Due	88	Venice	58	<b>Accessori per scorrevoli</b>	
Cometa	78	Venice Due	60	<b>Sliding door accessories</b>	<b>179</b>
Cottage	66	Wing	114	Accessori per scorrevoli	
Cottage Due	68	Zurigo	153	<i>Sliding door handles</i>	180
Daniela	126			Daniela	182
Daniela Porcellana	128	<b>Combinazioni - Combinations</b>	<b>156-157</b>	Lorena	182
Diana	108			Noxia	182
Doria	152	<b>Maniglioni - Pull handles</b>	<b>159</b>	Rettagolo	182
Elegant	144			Serrature - Locks	182
Elena	110	Barocco	166		
Emy	116	Beverly	160	<b>Articoli vari - Miscellaneous</b>	<b>183</b>
Fast	54	Cometa	165	Accessori - Spare parts	204
Funny	118	Cottage	162	Appendini - Portabiti	
Goccia	124	Cottage Due	162	<i>Hat &amp; coat hooks</i>	189
Handy	52	Daniela	164	Articoli vari - Miscellaneous	191
Katy	146	Daniela Porcellana	164	Bocchette - Escutcheons	197
Kristina	134	Diana	165	Bocchette di sicurezza	
Lady	84	Elena	164	<i>Security escutcheons</i>	196
Lara	153	Katy	166	Bucallettere - Letter plates	190
Latina	28	Latina	160	Catenacci - Bolts	188
Laura	136	Lirica	161	Meccanismi per finestre	
Link	42	Onda	165	<i>Window handles mechanisms</i>	206
Link Due	44	Only	161	Nottolini - Turns & releases	184
Link-B	46	Polo	166	Placche - Plates	200
Link-B Due	48	Sabina	165	Rosette - Roses	194
Lirica	92	Sara	166	Supporti corrimano - Handrail brackets	188
Lirica Porcellana	94	Slide	167		
Lisa	90	Thea	162		
Lorena	104	Venice	163		
Luna	153				
Melody	142			<b>Espositori - Displays</b>	<b>202</b>
Monica	130	<b>Pomoli - Knobs</b>	<b>169</b>		
Nina	138				
Nova	30	Diamante	171		
Nova Due	32	Easy	170		
Nova-B	34	Georgian	172		
Nova-B Due	36	Lorena	171		
Nova-C	38	Margherita	173		
Nova-C Due	40	Sfera	170		
Noxia	96	Victorian	172		
Noxia-B	98				
Onda	80				
Orizzonte	82				
Ovale	120				
Ovale centrale	122				
Paperino	154				
Polo	100				
Polo-B	102				



1968-2008





L'esperienza e la passione per la maniglia, protagonista nei gesti quotidiani, ci permette di presentare oggi questo nuovo e ricco catalogo, augurandoci di aver saputo interpretare le vostre esigenze di qualità, funzionalità e bellezza. Ogni articolo prodotto nasce da questa precisa ambizione.

Perché alla FMN Martinelli crediamo che il lavoro debba produrre opere di grande bellezza.

*Our experience and passion for the door handle enables us, today, to bring you this new and innovative catalogue in the hope that we have interpreted and captured the expectations of our Customers for quality, functionality and beauty.*

*In everything we do we strive to reflect this ambition, because at FMN Martinelli we believe that every activity should produce works of great beauty.*





## INDICE GENERALE - INDEX

- 1 Introduzione - *Introduction*
- 2 Martinelli nel mondo - *Martinelli in the world*
- 15 La nuova sfida - *The new challenge*
- 16 Qualità - *Quality*
- 17 Condizioni di vendita - *Sales terms*
- 19 Finiture - *Finishes*
- 23 Indice catalogo - *Catalogue index*
- 25 Maniglie e cremonesi - *Door and window handles*
- 155 Combinazioni - *Combinations*
- 159 Maniglioni - *Pull handles*
- 169 Pomoli - *Knobs*
- 175 Battenti - *Knockers*
- 179 Accessori per scorrevoli - *Sliding door accessories*
- 183 Articoli vari - *Miscellaneous*

MARTINELLI





La FMN Martinelli nasce nel 1968 in un territorio, la Valle Sabbia, che ha nel proprio dna la passione e la tradizione del lavoro, valori che l'azienda assume come propria missione. Un forte senso della qualità del proprio prodotto è alla base di ogni decisione; partendo dalla progettazione e dalla scelta dei materiali, attraversando tutte le fasi di lavorazione, fino alla valorizzazione delle risorse umane, alla comunicazione, e alla diffusione di prodotti che si sono guadagnati riconoscibilità e fiducia da parte di una clientela internazionale che condivide i nostri stessi valori.

E' con la profonda convinzione che la tradizione e l'innovazione siano valori forti, capaci di creare sinergia e sviluppo, che FMN Martinelli presenta e comunica la propria immagine e il proprio lavoro.

La tradizione parte da un materiale antico come l'ottone, lavorato e forgiato in forme che il tempo ha reso classiche e moderne. Impianti produttivi posti su un'area di 10.000 mq, al servizio di un'organizzazione del lavoro attenta a criteri di efficienza e sicurezza, realizzano linee di maniglie dove gusto classico e contemporaneo s'incontrano.

L'innovazione si esprime nella linea "dnd" (diffusione nuovo design), divisione interna che, nata come naturale risposta ad un mercato in costante evoluzione, vuole indicare nuove direzioni in termini di design e qualità.

*FMN Martinelli was established in 1968 in the Valle Sabbia, a region of Northern Italy which traditionally maintains its expertise and passion for brass foundry products, it's in our genes. These same values are still reflected today in our current mission statement for the Company.*

*Exhaustive research and continually striving to enhance the quality of our products is the basis for every decision; starting with detailed planning and the careful selection of quality raw materials, through all the working phases, bringing together the benefits of expert Human Resources, skilful communication and efficient distribution of products which has contributed to the popularity and trust we enjoy from our International Customers who all share and appreciate our values.*

*FMN Martinelli presents its own unique image and work ethic in the deep conviction that tradition and innovation are the essential components to continued development and maintaining a synergy with our valued Customers.*

*The tradition, starting with the timeless qualities of brass, worked and forged in various forms that over time now reflects both the classical and modern.*

*Our production plant is located on a 10.000 square meters site, and services a hard working organisation where attention to efficiency and safety have combined to create production lines of door handles where both the classic and contemporary merge.*

*Our innovation expresses itself magnificently with the "dnd" line (diffusion of new design), an internal division born as a natural answer to the demands of a market in constant evolution. "dnd" is indicative of a new direction and our commitment to design and quality concerns.*





**Uffici amministrativi e commerciali.**

Efficienza, disponibilità e cortesia al servizio della clientela.  
La progettazione e la ricerca: elementi fondamentali per la realizzazione del nostro prodotto.

**Administrative and commercial departments.**

*Efficiency, willingness to help and courtesy at the Customer's service  
Planning and research Fundamental elements for the realization of our product.*

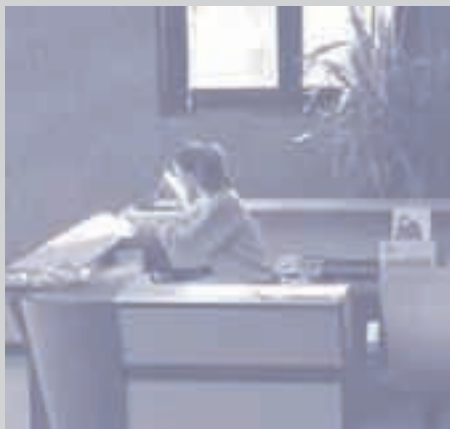







**Reparto fonderia.**

La fusione e lo stampaggio dell'ottone. La prima fase del ciclo dove l'utilizzo di macchinari all'avanguardia e la cura nella scelta della materia prima, sono elementi fondamentali per il raggiungimento della qualità del prodotto finale.

**Foundry department.**

*The casting and press-forging of brass. The first phase of the production cycle, where the utilization of advanced machineries and the care used to choose the raw material are fundamental to reach the quality of the final product.*









### **Reparto pulitura**

Il braccio del robot per il raggiungimento di elevati standard qualitativi.  
Le mani esperte dell'uomo che con cura artigianale rendono ogni pezzo un oggetto di grande valore.

### **Polishing department**

*The arm of the robot for the achievement of high quality standards.  
The skilled hands of a man who, with artisan care, is making of each piece an object of great value.*





**Momenti di vita aziendale.**

La tecnologia al servizio dell'uomo per il raggiungimento di ambiziosi traguardi.

***Moments of business everyday life***

*Technology at the man's service for the achievement of ambitious goals*







**Reparto imballaggio-spedizione.**

Durante la fase finale del ciclo di produzione l'ultimo controllo viene da sempre affidato alla conoscenza dell'uomo, oggi supportato da impianti tecnologicamente avanzati che garantiscono la massima cura nel packaging.

***Packing and shipping department***

*During the final phase of production cycle, the last testing for approval is always secured by the man's knowledge, supported today by technologically advanced plants which guarantee the best care for the packaging.*

Si ringraziano il personale ed i collaboratori esterni per il costante impegno e partecipazione tesi al raggiungimento di nuovi obiettivi.

*Our thanks to the staff and external collaborators for the constant care and participation to our activity striving to achieve new objectives.*



L'EVOLUZIONE  
DEI LOGO NELLA STORIA  
LOGO EVOLUTION  
IN ITS HISTORY



1968



1978



1982



1992



1995



2007



1998



2007



## LA NUOVA SFIDA

### **Riteniamo l'azienda creatrice di valori, oltre che di prodotti.**

Nel marketing comunicazionale ogni azienda è sempre più percepita come realtà che propone valori oltre che prodotti, comunicati e fruiti come elementi di identità e posizionamento. Questi valori "immateriali", ma molto concreti, formano la corporate identity.

### **La creatività risponde a tre elementi coordinati.**

- identificazione coerente: l'immagine dell'azienda deve presentarsi in maniera comprensibile, distinguibile: Le differenti parti attive che lo compongono devono essere correlate tra loro, in modo da restituire sempre un quadro generale.

- riverberazione segnica: il brand deve riuscire a esprimere, anche in territori applicativi diversificati, la sua missione e i suoi obiettivi, tramite l'uso di segni condivisi

- posizionamento: il brand, tramite un linguaggio visuale appropriato, deve posizionarsi sul mercato e riuscire a distinguere se stesso e i suoi prodotti dalle imprese concorrenti

### **I valori di riferimento.**

- attenzione al design (ma più in generale agli stili contemporanei)
- capacità di unire estetica e funzionalità
- innovazione senza rinunciare alla tradizione
- internazionalità, pur ribadendo l'originale made in Italy

dnd® è il nuovo marchio di fabbrica della FMN Martinelli S.p.A. Nato nel 1998 allo scopo di dare un esito produttivo a un aspetto della nostra attività che è spesso solo sulla carta o allo stadio di prototipi: il desiderio di portare avanti ricerche con un alto grado di innovazione formale, costruttiva e funzionale, anche di tipo sperimentale, libere dai limiti normalmente imposte dalle produzioni industriali di grande serie.

Desideriamo offrire ad un pubblico attento e culturalmente curioso un ampio spettro di proposte con la ricerca condotta di alcune delle personalità più interessanti dell'attuale panorama del disegno industriale.

Non antagonista, ma complementare alla produzione con il marchio "martinelli" (che continua la strada che è la propria degli oggetti di grande serie per il vasto pubblico, documentata dall'annuario della produzione martinelli), proveniente dalla stessa fabbrica di Casto e dalle sue abili maestranze. la nuova produzione con il marchio "dnd" si ritaglia dunque nuovi spazi nel panorama sempre più articolato e complesso del mercato contemporaneo.

## THE NEW CHALLENGE

### **We consider the Company creator of values, not just products.**

*In communication marketing, each Company is perceived more and more as an entity offering values, in addition to products, information and benefits, as tools for defining its identity and position. These "immaterial" but very tangible values are what build the corporate identity.*

### **Creativity provides the answer to three interlinked elements**

- *Consistent identification: the Company image needs to be presented in a way which is comprehensible and unique. Its various active components need to be correlated and capable of presenting a general view.*

- *Graphic representation: the brand needs to clearly express the Company's mission and objectives, by means of widely understood symbols and within varied fields of application.*

- *Positioning: the use of an appropriate visual language needs to be implemented, ensuring that the brand finds its proper positioning within the market and separates itself and the products it represents from competing organisations.*

### **The reference values**

- *attention to design (and, in more general terms, to contemporary styles)*
- *ability to combine aesthetics to functionality*
- *innovation and research without renouncing to the tradition*
- *internationality, whilst emphasizing the "Made in Italy" concept*

*dnd® is a new brand name of FMN Martinelli S.p.A.*

*Born in 1998 to give a production answer to our activity specifics which are often only on paper or at the stage of prototypes: the desire of bringing forward researches with a very high degree of formal innovation, constructive and functional, even experimental, free from the limits normally given by the industrial productions of big series.*

*We wish to offer to an attentive and culturally curious public a wide spectrum of proposals made by some of the most interesting personalities in the current Industrial Design panorama.*

*Not antagonistic, but complementary with the "martinelli" brand (which continues its own way for the objects directed to the wide public, showed in the Martinelli catalogue) the new production with the brand "dnd", originated by the same Factory at Casto and capable craftsmen, has his own and new scopes in the more and more complex and articulate panorama of the contemporary market.*



#### QUALITA'

Il 31 dicembre 2001 l'Azienda ha ottenuto la certificazione del proprio sistema di qualità in base alle normative UNI EN ISO 9002:1994.

Il sistema qualità in seguito è stato integrato con la progettazione interna ed il 17/07/2003 l'Azienda ha ottenuto la certificazione in base alle nuove normative UNI EN ISO 9001:2000.

La certificazione è stata rilasciata da DNV - DET NORSKE VERITAS tra i più prestigiosi enti di certificazione internazionali.

Il sistema di gestione della Qualità aziendale secondo le norme UNI EN ISO 9001:2000 consente di controllare costantemente lo standard qualitativo di ogni processo produttivo, di selezionare i fornitori, di monitorare la qualità dei servizi rivolti alla clientela.

#### PROGETTAZIONE.

L'ufficio tecnico dell'Azienda con la collaborazione frequente di designer esterni pone la massima attenzione alla realizzazione dei nuovi progetti al fine di ottenere prodotti funzionali associati alle attuali esigenze estetiche.

#### FORMAZIONE DELLE RISORSE UMANE.

L'azienda investe numerose risorse nell'addestramento e nella formazione delle maestranze e del personale addetto, con l'intento di creare una sempre maggiore consapevolezza e partecipazione che garantiscano un continuo miglioramento della qualità aziendale.

#### AMBIENTE DI LAVORO

Particolare attenzione viene posta alla tutela della salute negli ambienti di lavoro. Periodicamente vengono effettuati indagini che permettono di controllare i livelli fonometrici e la salubrità dei locali.

#### PRODUZIONE

I vari processi produttivi svolti con l'utilizzo di macchinari e tecnologie all'avanguardia sono continuamente monitorati. I prodotti subiscono un controllo qualitativo in ogni fase di lavorazione ed un collaudo finale in fase di assemblaggio.

#### MONITORAGGIO

Periodicamente viene analizzato il processo aziendale con particolare attenzione alle non conformità riscontrate.

#### SODDISFAZIONE DEL CLIENTE

Una continua e costante attenzione è tesa ad ottenere la massima soddisfazione del Cliente che trova assistenza e disponibilità in tutte le fasi del rapporto.

#### QUALITY

*At December 31st. 2001 FMN Martinelli SpA obtained the Certification of its own Quality System in conformity with UNI EN ISO 9002:1994 specifications.*

*The Company Quality System has then been supplemented by internal planning and at July 17th. 2003 our Factory obtained the Certification in accordance with the UNI EN ISO 9001:2000 new specifications.*

*The Certification has been issued by DNV - DET NORSKE VERITAS one of the most prestigious Corporations for International Certification.*

*The Company Quality System in conformity with the UNI EN ISO 9001:2000 specifications allows us to constantly examine the quality standard during each production process, to select suppliers and monitor the quality of services offered to our customers.*

#### DEVELOPMENT

*The Technical Department of FMN Martinelli SpA, supported by frequent co-operation with external Designers, gives maximum attention to the realization of new projects which are both functional whilst at the same time corresponding to current aesthetic requirements.*

#### HUMAN RESOURCES

*FMN Martinelli SpA invests large resources to ensure that there is continued improvement and awareness within the Company.*

#### WORKING ENVIRONMENT

*Particular attention is given to the health and safety aspects within the working environment. The Company carry out periodical investigations which allow us to control the phonomy level as well as the healthiness of the working environment.*

#### PRODUCTION

*The various production phases made by the utilization of machinery and avant-garde technology are under continuous monitoring. The quality of the products is inspected during all the manufacturing phases. The final testing for approval is made during the assembling phase.*

#### MONITORING

*The Company Quality System has periodical investigations with particular attention paid to the non-conformities we've registered.*

#### CUSTOMER SATISFACTION

*Continuous and constant attention is paid to ensure maximum Customer satisfaction. Assistance and willingness to help is guaranteed to the Customer during all phases of the business relationship.*



## CONDIZIONI GENERALI DI VENDITA

### ORDINI

Tutti gli ordini ricevuti direttamente o tramite nostri Agenti sono subordinati all'accettazione della Casa.

Gli ordini telefonici o verbali sono considerati validi dopo il ricevimento della conferma d'ordine.

Eventuali aggiunte agli ordini già in corso vengono accettate con riserva e possono ritardare il termine di consegna concordato.

La FMN Martinelli SPA non è ritenuta responsabile di errori nell'evasione degli ordini se questi sono causati da errata o incompleta indicazione nell'ordine.

La FMN Martinelli SPA si riserva il diritto di apportare modifiche ai prodotti, ritenute necessarie, senza preavviso alcuno. Le misure tecniche indicate nel presente catalogo sono indicative.

### CONSEGNA

La FMN Martinelli SPA si impegna a rispettare il più fedelmente possibile la data di consegna richiesta dal Committente. La data di consegna stabilita ha comunque solo carattere indicativo. Eventuali ritardi e la mancata o parziale consegna non comportano richieste di indennizzo. Gli ordini possono essere evasi anche parzialmente con riserva da parte della Casa di annullare la rimanenza.

### PREZZI

I prezzi esposti nel listino si intendono in Euro IVA esclusa, resa franco nostra fabbrica. Gli stessi possono essere aumentati anche prima dell'evasione dell'ordine se nel frattempo intervengono forti variazioni sul costo della materia prima.

### IMBALLI

Gli imballi sono compresi nel prezzo. Le quantità sono indicate nel listino. Per ordini di quantità inferiore la FMN Martinelli SPA si riserva di aumentarla fino a raggiungere il quantitativo della confezione. Per richieste di quantitativi inferiori viene applicata una maggiorazione del 10% sul prezzo di listino.

### VALORE MINIMO D'ORDINE

Il valore minimo dell'ordine è di Euro 350,00. Per ordini di importo inferiore viene addebitato un extra di Euro 35,00.

### TRASPORTO

La merce viaggia sempre ad esclusivo rischio del Committente, anche se resa franco destino. La FMN Martinelli SPA non è responsabile per ritardi, manomissioni, furti o altre mancanze avvenute durante il trasporto.

Il Committente ha l'obbligo di ritirare la merce e verificarne la conformità al momento della consegna. In caso di mancato ritiro vengono o addebitate tutte le spese sostenute oltre ad una ritenuta del 20% sul valore della merce ritornata in perfetto stato.

Le spese di trasporto sono sempre a carico del Committente, salvo particolari accordi.

### RECLAMI

Eventuali reclami devono essere fatti pervenire presso la sede della FMN Martinelli SPA entro e non oltre otto giorni dal ricevimento della merce, pena la decadenza. Per prodotti difettosi o non corrispondenti all'ordine la FMN Martinelli SPA ritirerà il materiale a proprie spese effettuandone la sostituzione o accreditandone l'importo relativo. Nessun altro risarcimento è dovuto.

### PAGAMENTI

I pagamenti devono essere effettuati nei termini convenuti ed inoltrati esclusivamente al domicilio della FMN Martinelli SPA.

In caso di ritardato pagamento, la pretesa degli interessi, ai sensi del D.Lgs. 231/2002, sarà richiesta previa la messa in mora, ai tassi previsti dallo stesso decreto legislativo.

### RISERVA DI PROPRIETA'

La merce fornita rimane di proprietà della FMN Martinelli SPA fino al pagamento completo della stessa. Anche nel caso in cui la merce venga rivenduta, pignorata o acquisita da procedura fallimentare o concorsuale.

Il ricavato di una vendita anche forzata andrà alla FMN Martinelli SPA fino ad esaurimento del credito.

### COMPETENZA

Per qualsiasi controversia si intende competente il Foro di Brescia

## GENERAL SALES CONDITIONS

### ORDERS

All direct orders as well as those received through our Agents are subject to our approval.

Orders received by telephone or verbally are only considered valid after receipt of order confirmation. Any addition to orders on which production has started are accepted with reserve and may delay the agreed delivery terms.

FMN Martinelli SPA is not responsible for mistakes in the execution of the orders if these are caused by incorrect or incomplete information received in the original order. FMN Martinelli SPA reserves the right to bring modifications to the products, which are considered necessary, without any prior information. The technical measurements indicated in this catalogue are indicative.

### DELIVERY

FMN Martinelli SpA undertakes to respect, wherever possible, the delivery date requested by the Buyer. However, all despatch dates quoted by FMN Martinelli are to be considered approximate. Any delay, missing or partial shipment do not entitle the Buyer to any claim or indemnity. All orders can also be partially shipped and we reserve the right to cancel any balances outstanding.

### PRICES

All prices quoted are ex-VAT. Should any heavy increase in cost of raw material occur then we reserve the right to increase prices even before shipment of the order.

### PACKING

All packing is included in the price. Box quantities are indicated in the price-list. FMN Martinelli reserve the right to increase any smaller quantities to box quantity. If this is not acceptable to the Buyer then we may apply a surcharge of 10% to price quoted in the price list.

### MINIMUM ORDER VALUE

The minimum order value we accept is Eur 350,00. For lower value orders we may apply a surcharge of Eur 35,00.

For export orders – please contact our export department for more information.

### TRANSPORT

The goods always travel at the Buyer's risk even if goods are delivered carriage paid. FMN Martinelli SpA is not responsible for delays, tamperings, burglaries or other shortcomings during the carriage.

The Buyer is bound to collect the goods and check their conformity on arrival.

In case of non-collection of the goods, we will debit the Buyer with all costs incurred plus a 20% of the goods value as re-stocking charge when the goods are returned to us. The transport costs are always at Buyer's expense unless special terms have been agreed.

### CLAIMS

Claims for shortages, damaged goods or incorrect supply must be made within 8 days from receipt of order.

In the event of goods proving faulty we will replace them or credit them but in doing so, no further liability, consequential or otherwise, is accepted.

No further indemnity is due.

### PAYMENT

All payments are to be made within the agreed terms and exclusively to the domicile of FMN Martinelli SpA.

In case of delayed payment interest will be charged, according to the Decree Law 231/2002, at the rates stated by the same Decree Law.

### RESERVE OF OWNERSHIP

All goods remain property of FMN Martinelli SpA until they are paid for in full.

All goods remain of our ownership even if passed to a third party, distrained or acquired by bankruptcy.

All proceeds from a sale even forced will be passed to FMN Martinelli SpA until the complete clearance of the credit.

### JURISDICTION:



For any dispute, the jurisdiction is the Law Court of Brescia, Italy.



FINITURE

## FINITURE

### Finiture su ottone

<b>OL</b>	Ottone lucido non verniciato
<b>OLV</b>	Ottone lucido verniciato
<b>OS</b>	Ottone satinato
<b>OLS</b>	Ottone lucido + ottone satinato
<b>OBO</b>	Ottone bronzato
<b>OF</b>	Ottone sfumato
<b>OGR</b>	Ottone bronzo graffiato
<b>OGH</b>	Ottone bronzo graffiato chiaro vernice opaca
<b>OGC</b>	Ottone bronzo graffiato chiaro
<b>OBS</b>	Ottone bronzo satinato
<b>AF</b>	Ottone anticato
<b>AB</b>	Ottone bronzo antico
<b>OBV</b>	Ottone bronzo vibrato
<b>15V</b>	Ottone lucido anticato non verniciato
<b>BSS</b>	Ottone bronzo scuro sfumato
<b>OC</b>	Ottone cromo lucido
<b>OCS</b>	Ottone cromo satinato
<b>CCS</b>	Ottone cromo lucido + cromo satinato
<b>CNS</b>	Ottone cromo lucido + nickel satinato
<b>FAN</b>	Ottone ferro anticato
<b>SIL</b>	Ottone argento antico
<b>ONS</b>	Ottone nickel satinato
<b>ORO</b>	Ottone placcato oro 24K
<b>ORA</b>	Ottone placcato oro 24K + ottone nickel
 <b>PVD</b>	PVD colore ottone
 <b>PVD INOX</b>	PVD colore acciaio

### Finiture su ottone con porcellana



<b>OLV + P1</b>	Ottone lucido + porcellana bianca
<b>OLV + P7</b>	Ottone lucido + porcellana beige
<b>AF + P1</b>	Ottone anticato + porcellana bianca
<b>AF + P2</b>	Ottone anticato + porcellana beige "speckled"
<b>AF + P6</b>	Ottone anticato + porcellana avorio
<b>AF + P8</b>	Ottone anticato + porcellana beige "crackled"
<b>AB + P2</b>	Ottone bronzo antico + porcellana beige "speckled"
<b>AB + P6</b>	Ottone bronzo antico + porcellana avorio
<b>AB + P7</b>	Ottone bronzo antico + porcellana beige
<b>AB + P8</b>	Ottone bronzo antico + porcellana beige "crackled"
<b>OBV + P2</b>	Ottone bronzo vibrato + porcellana beige "speckled"
<b>OBV + P6</b>	Ottone bronzo vibrato + porcellana avorio
<b>OC + P9</b>	Ottone cromo lucido + porcellana bianca "crackled"
<b>FAN + P1</b>	Ottone ferro anticato + porcellana bianca
<b>ONS + P9</b>	Ottone nickel satinato + porcellana bianca "crackled"

### Finiture su ottone con legno

<b>LCI</b>	Ottone lucido + legno colore ciliegio
<b>LPI</b>	Ottone lucido + legno pino
<b>LRC</b>	Ottone lucido + rovere chiaro
<b>SCI</b>	Ottone cromo satinato + legno colore ciliegio
<b>NPA</b>	Ottone nickel satinato + palissandro

## FINISHES

### Finishes on brass material

Polished brass unlacquered
Polished brass lacquered
Satin brass
Polished brass + satin brass
Bronze
Shaded bronze
Satin scratched bronze
Light satin scratched bronze matt lacquered
Light satin scratched bronze
Satin bronze
Antique finish
Antique bronze
Tumbled bronze
Antique finish unlacquered
Dark shaded bronze
Polished chrome
Satin chrome
Polished chrome + satin chrome
Polished chrome + satin nickel
Antique iron
Antique silver brass
Satin nickel
Gold plated 24K
Gold plated 24K + black nickel
 Stainless brass
 Stainless brass - steel finish

### Finishes on brass & porcelain

Polished brass + white porcelain
Polished brass + beige porcelain
Antique finish + white porcelain
Antique finish + speckled beige porcelain
Antique finish + ivory porcelain
Antique finish + beige "cracked" porcelain
Antique bronze + speckled beige porcelain
Antique bronze + ivory porcelain
Antique bronze + beige porcelain
Antique bronze + beige "crackled" porcelain
Tumbled bronze + speckled beige porcelain
tumbled bronze + ivory porcelain
Polished chrome + white "crackled" porcelain
Antique iron + white porcelain
Satin nickel + white "crackled" porcelain

### Finishes on brass & wood

Polished brass + cherry coloured wood
Polished brass + pine wood
Polished brass + light oak wood
Satin chrome + cherry coloured wood
Satin nickel + palisander wood

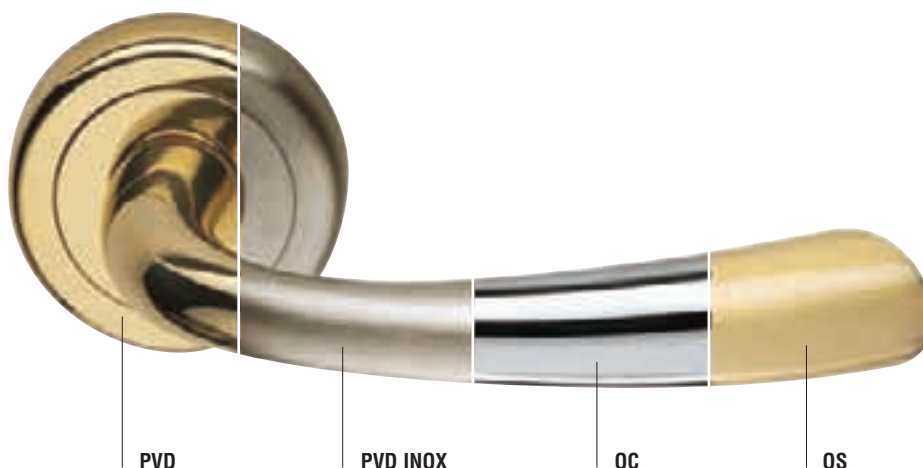

**PVD - PVD INOX: Stainless Brass®**

Rivestimento metallico sottovuoto denominato PVD (Physical Vapor Deposition).  
 Inossidabile, anti-graffio e anti-usura.  
 Mantiene inalterato nel tempo il colore di origine.  
 Il rivestimento testato in nebbia salina in base alle norme ISO 9227 ASTM B117 DIN 50021 ha superato le 1500 ore di resistenza.  
 Garantito 20 anni (in normali condizioni di utilizzo)  
 Per la pulizia di questo rivestimento consigliamo di utilizzare un panno morbido inumidito con alcool.

*PVD - PVD INOX: Stainless Brass®  
 Metallic coating named PVD (Physical Vapor Deposition).  
 Inoxidizable, scratch-resistant and wearproof, PVD maintains the*

*original colour unchanged over the time.  
 PVD coating exceeded 1500 hours in the salt fog resistance test in accordance with the ISO 9227 ASTM B117 DIN 50021 specifications  
 PVD is guaranteed for 20 years (for normal use conditions)  
 When cleaning this coating we suggest to use a soft cloth moisted with alcohol only.*

**OC**  
 ottone brillante con applicazione di cromo  
*bright brass with chrome plating*

**OS**  
 colore naturale dell'ottone satinato  
*the natural colour of brass by silking operation*

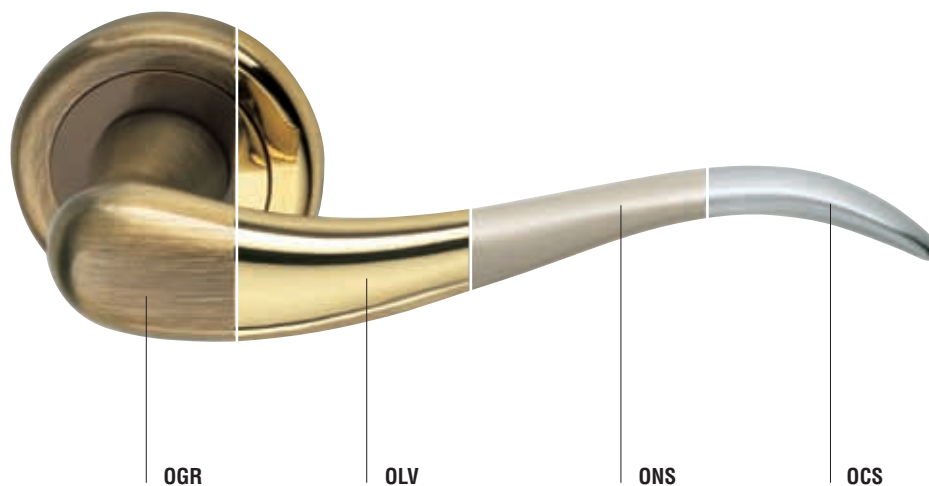

**OGR**  
 graffiatura manuale dell'ottone bronzato  
*manual "scratching" of the bronze finish on brass*

**OLV**  
 il colore naturale dell'ottone reso brillante mediante spazzolatura  
*the natural colour of brass made bright by the polishing operation*

**ONS**  
 ottone satinato con applicazione di nickel  
*satin brass with nickel plating*

**OCS**  
 ottone satinato con applicazione di cromo  
*satin brass with chrome plating*

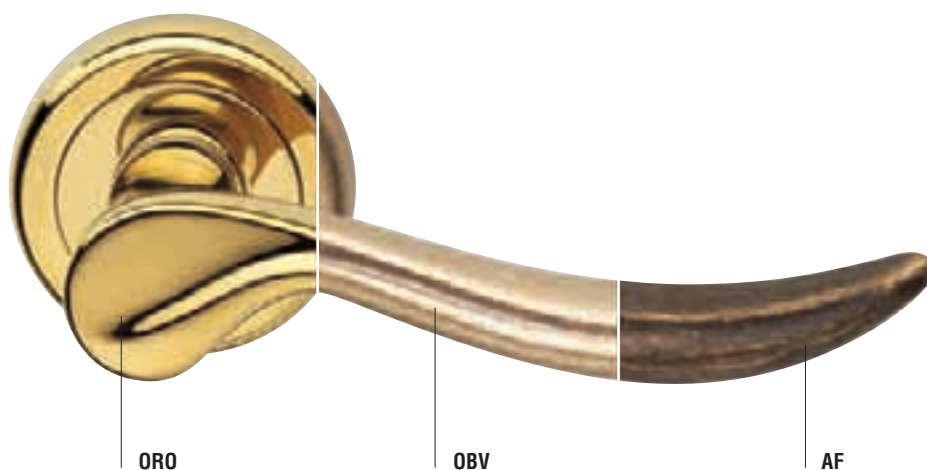

**ORO**

ottone placcato oro 24K  
*bright brass with 24K Gold plating*

**OBV**

particolare processo di invecchiamento dell'ottone naturale  
*particular process of "ageing" of the natural brass*

**AF**

particolare processo di invecchiamento dell'ottone bronzato  
*particular process of "ageing" of the bronze finish on brass*

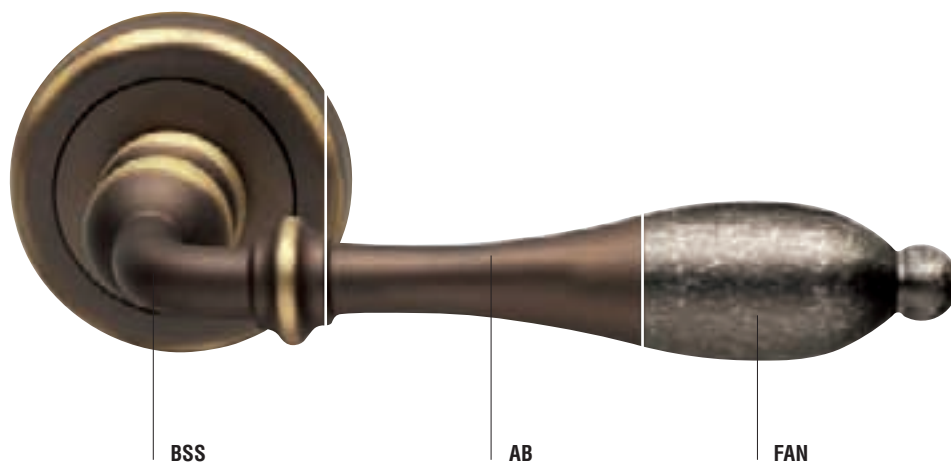

**AB**

bronzatura opaca ed uniforme dell'ottone  
*dull and plain bronze finish on brass*

**BSS**

bronzatura satinata con sfumature  
*dark shaded bronzee*

**FAN**

particolare processo di invecchiamento dell'ottone cromato  
*particular process of "ageing" of brass chrome plated*

Consigli per l'uso e la manutenzione:

Procedere al montaggio solo dopo l'eventuale tinteggiatura di pareti ed infissi e dopo l'eventuale trattamento dei pavimenti.  
Per la pulizia dei prodotti usare solo un panno morbido ed asciutto.

*Suggestions for use and maintenance:*

*Only proceed to mount the product after the eventual painting/lacquering of walls, windows or doors and after the eventual treatment for floors. When cleaning the products use a soft dry cloth only.*

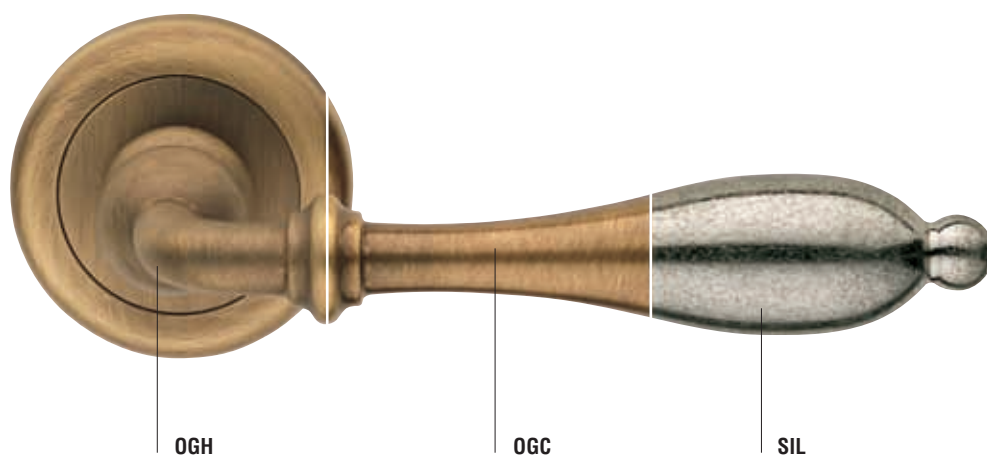

**OGH**

Ottone bronzo graffiato chiaro vernice opaca  
*Light satin scratched bronze matt lacquered*

**OGC**

Ottone bronzo graffiato chiaro  
*Light satin scratched bronze*

**SIL**

Ottone argento antico  
*Antique silver brass*

Consigli per l'uso e la manutenzione:

Procedere al montaggio solo dopo l'eventuale tinteggiatura di pareti ed infissi e dopo l'eventuale trattamento dei pavimenti.  
Per la pulizia dei prodotti usare solo un panno morbido ed asciutto.

*Suggestions for use and maintenance:*

*Only proceed to mount the product after the eventual painting/lacquering of walls, windows or doors and after the eventual treatment for floors.  
When cleaning the products use a soft dry cloth only.*

<b>Maniglie - Door handles</b>	<b>25</b>	Posthorn	153	<b>Battenti - Knockers</b>	<b>175</b>
Airone	50	Prelude	140	America	177
Appia	26	Rosy	132	Anello	177
Arcadia	70	Round	62	Barocco	176
Beauty	148	Sabina	112	Esagono	176
Beverly	56	Siria	153	Georgian	177
Boomerang	64	Techna	72	Leone	176
Bruxelles	150	Tesa	74	Victorian	177
Carola	106	Tipo	76		
Classic	86	Venere	152		
Classic Due	88	Venice	58	<b>Accessori per scorrevoli</b>	
Cometa	78	Venice Due	60	<b>Sliding door accessories</b>	<b>179</b>
Cottage	66	Wing	114	Accessori per scorrevoli	
Cottage Due	68	Zurigo	153	<i>Sliding door handles</i>	180
Daniela	126			Daniela	182
Daniela Porcellana	128	<b>Combinazioni - Combinations</b>	<b>156-157</b>	Lorena	182
Diana	108			Noxia	182
Doria	152	<b>Maniglioni - Pull handles</b>	<b>159</b>	Rettangolo	182
Elegant	144	Barocco	166	Serrature - Locks	182
Elena	110	Beverly	160		
Emy	116	Cometa	165	<b>Articoli vari - Miscellaneous</b>	<b>183</b>
Fast	54	Cottage	162	Accessori - Spare parts	204
Funny	118	Cottage Due	162	Appendini - Portabiti	
Goccia	124	Daniela	164	<i>Hat &amp; coat hooks</i>	189
Handy	52	Daniela Porcellana	164	Articoli vari - Miscellaneous	191
Katy	146	Diana	165	Bocchette - Escutcheons	197
Kristina	134	Elena	164	Bocchette di sicurezza	
Lady	84	Katy	166	<i>Security escutcheons</i>	196
Lara	153	Latina	160	Bucallettere - Letter plates	190
Latina	28	Lirica	161	Catenacci - Bolts	188
Laura	136	Onda	165	Meccanismi per finestre	
Link	42	Only	161	<i>Window handles mechanisms</i>	206
Link Due	44	Polo	166	Nottolini - Turns & releases	184
Link-B	46	Sabina	165	Placche - Plates	200
Link-B Due	48	Sara	166	Rosette - Roses	194
Lirica	92	Slide	167	Supporti corrimano - Handrail brackets	188
Lirica Porcellana	94	Thea	162		
Lisa	90	Venice	163		
Lorena	104			<b>Espositori - Displays</b>	<b>202</b>
Luna	153				
Melody	142	<b>Pomoli - Knobs</b>	<b>169</b>		
Monica	130	Diamante	171		
Nina	138	Easy	170		
Nova	30	Georgian	172		
Nova Due	32	Lorena	171		
Nova-B	34	Margherita	173		
Nova-B Due	36	Sfera	170		
Nova-C	38	Victorian	172		
Nova-C Due	40				
Noxia	96				
Noxia-B	98				
Onda	80				
Orizzonte	82				
Ovale	120				
Ovale centrale	122				
Paperino	154				
Polo	100				
Polo-B	102				





# MANIGLIE

DOOR AND WINDOW HANDLES



MANIGLIE

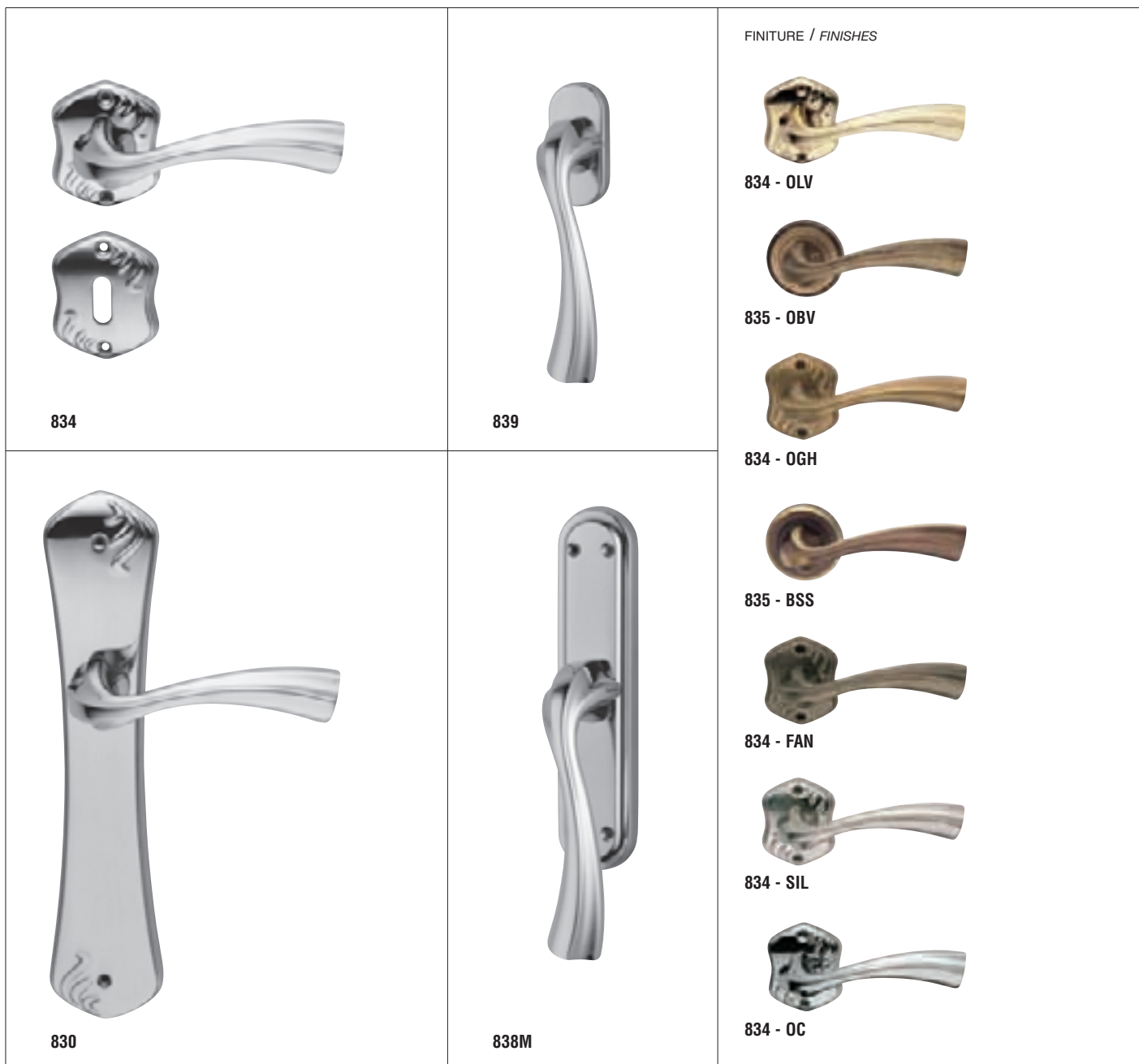

**830**  
Maniglia su placca Latina  
*Door handle on Latina plate*

**831**  
Maniglia su placca Cometa  
*Door handle on Cometa plate*

**834**  
Maniglia su rosetta e bocchetta  
Latina  
*Door handle on Latina rose  
and escutcheon*

**835**  
Maniglia su rosetta e bocchetta  
ottone 55 mm  
*Door handle on brass rose  
and escutcheon 55 mm*

**838C**  
Cremonese con meccanismo  
*Window handle with mechanism*

**838M**  
Martellina q.7 senza meccanismo  
*Window handle 7 mm square  
without mechanism*

**839**  
Martellina DK  
*DK window handle*

FINITURE / FINISHES  
**OLV - OS - OGC - OBV - OGH - BSS**  
**FAN - SIL - OC - OCS - ONS - PVD**  
**INOX**

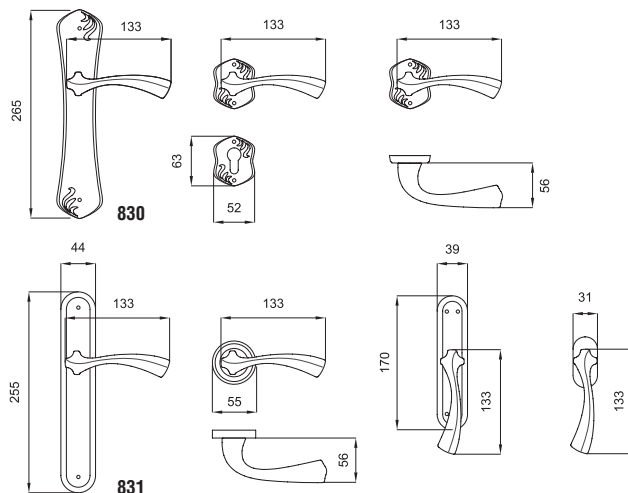

# APPIA

**martinelli**  
HANDLES WITH CARE



**834 SIL**

Maniglia su rosetta e bocchetta Latina

*Door handle on Latina rose and escutcheon*

DESIGN:  
MAURO RONCHI

# APPIA



FINITURE / FINISHES



**820**  
Maniglia su placca Latina  
*Door handle on Latina plate*

**821**  
Maniglia su placca Cometa  
*Door handle on Cometa plate*

**824**  
Maniglia su rosetta e bocchetta  
Latina  
*Door handle on Latina rose  
and escutcheon*

**825**  
Maniglia su rosetta e bocchetta  
ottone 55 mm  
*Door handle on brass rose  
and escutcheon 55 mm*

**828C**  
Cremonese con meccanismo  
*Window handle with mechanism*

**828M**  
Martellina q.7 senza meccanismo  
*Window handle 7 mm square  
without mechanism*

**829**  
Martellina DK  
*DK window handle*

FINITURE / FINISHES  
**OLV - OS - OGC - OBV - OGH - BSS  
FAN - SIL - OC - OCS - ONS - PVD  
INOX**

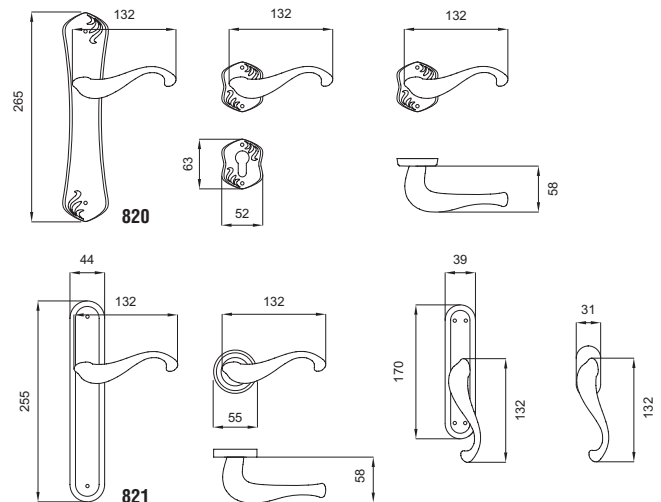

# LATINA

**martinelli**  
HANDLES WITH CARE



**824 OLV**

Maniglia su rosetta e bocchetta Latina

*Door handle on Latina rose and escutcheon*

DESIGN:  
MAURO RONCHI

# LATINA

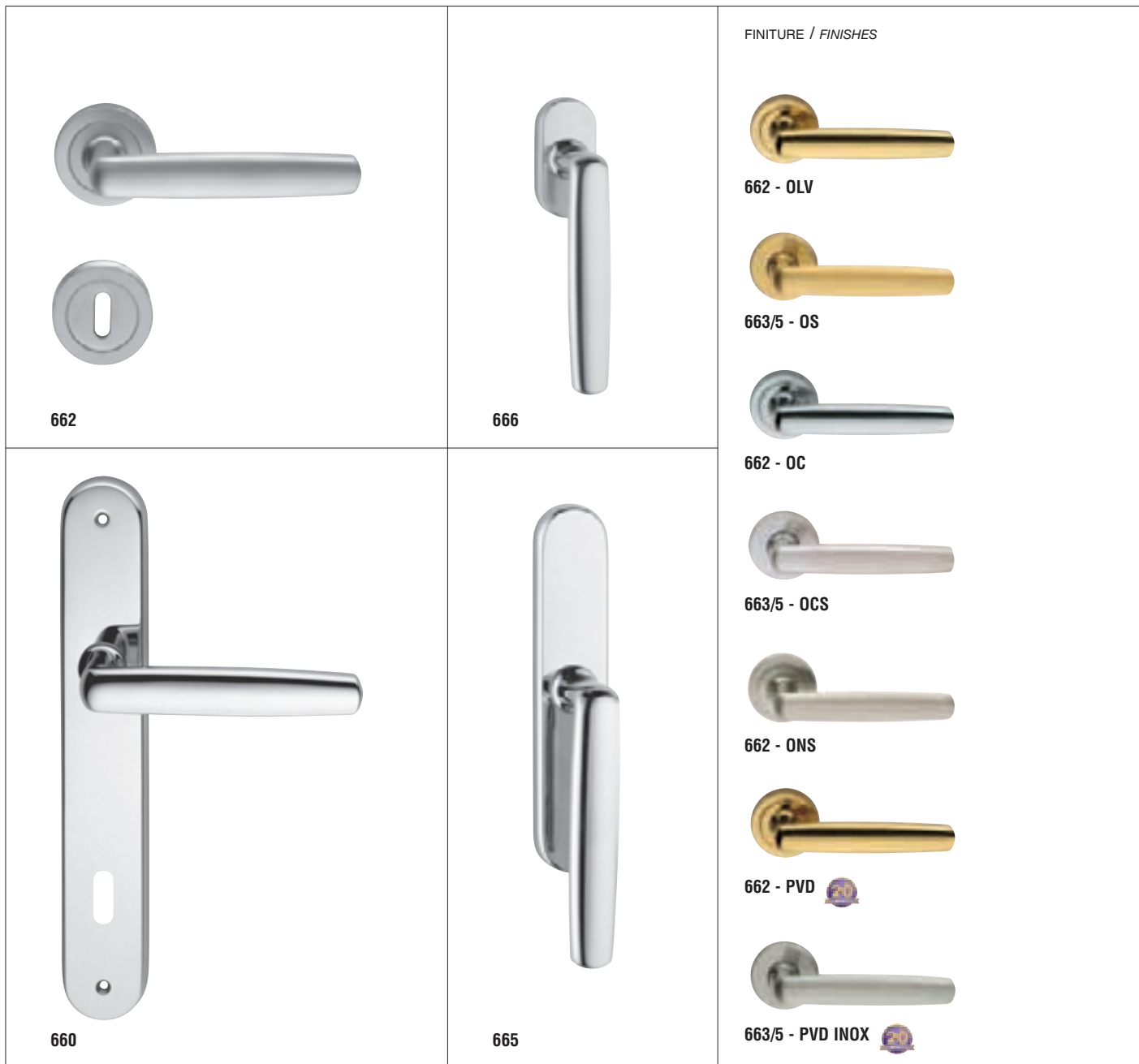

**660**  
Maniglia su placca  
*Door handle on plate*

**662**  
Maniglia su rosetta e bocchetta  
ottone 50 mm  
*Door handle on brass rose  
and escutcheon 50 mm*

**662/B**  
Maniglia su rosetta e bocchetta  
ottone bombata 50 mm  
*Door handle on rounded brass rose  
and escutcheon 50 mm*

**663**  
Maniglia su rosetta e bocchetta  
nylon 45 mm  
*Door handle on nylon rose  
and escutcheon 45 mm*

**663/5**  
Maniglia su rosetta e bocchetta  
nylon 50 mm  
*Door handle on nylon rose  
and escutcheon 50 mm*

**663/2G**  
Maniglia su rosetta e bocchetta  
nylon 52 mm con rilievo  
*Door handle on nylon rose  
and escutcheon 52 mm with relief*

**664**  
Cremonese con meccanismo  
*Window handle with mechanism*

**665**  
Martellina con meccanismo  
q. 7x45 mm  
*Window handle with mechanism  
and 7x45 mm spindle*

**666**  
Martellina DK  
*DK window handle*

FINITURE / FINISHES  
**OLV - OS - OC - OCS - ONS**  
**PVD - PVD INOX**

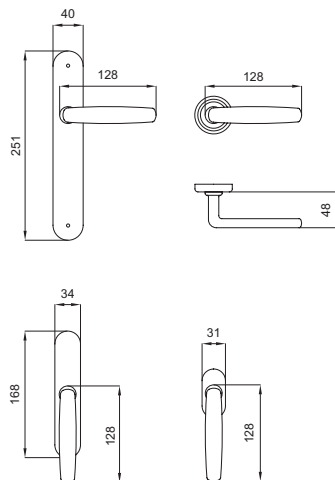

# NOVA

**martinelli**  
HANDLES WITH CARE

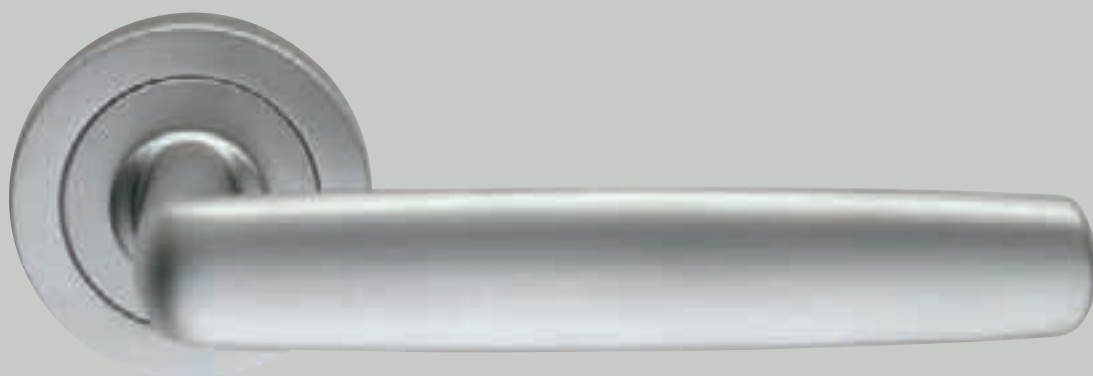

**662 OCS**

Maniglia su rosetta e bocchetta ottone 50 mm

*Door handle on brass rose and escutcheon 50 mm*

DESIGN:  
MAURO RONCHI

# NOVA



FINITURE / FINISHES

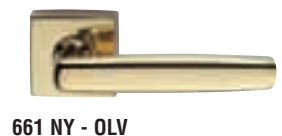

**659**  
 Maniglia su placca Quadra  
*Door handle on Quadra plate*

**661NY**  
 Maniglia su rosetta e bocchetta  
 quadra nylon 50 mm  
*Door handle on nylon square rose  
 and escutcheon 50 mm*

**667**  
 Cremonese con meccanismo  
*Window handle with mechanism*

**668**  
 Martellina q.7 senza meccanismo  
*Window handle 7 mm square  
 without mechanism*

**668DK**  
 Martellina DK quadro  
*Square DK window handle*

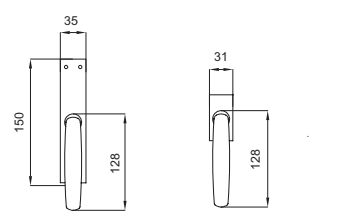
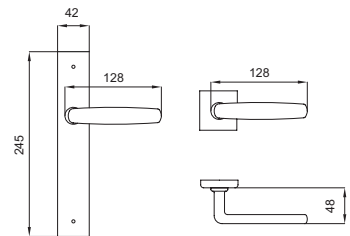

FINITURE / FINISHES  
**OLV - OS - OC - OCS - ONS**  
**PVD - PVD INOX**



# NOVA DUE

**martinelli**  
HANDLES WITH CARE









**661NY OC**

Maniglia su rosetta e bocchetta quadra nylon 50 mm  
*Door handle on nylon square rose and escutcheon 50 mm*

DESIGN:  
MAURO RONCHI

# NOVA DUE

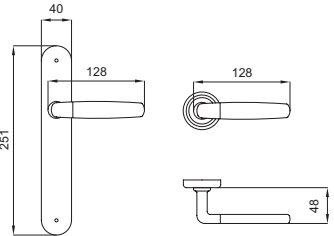
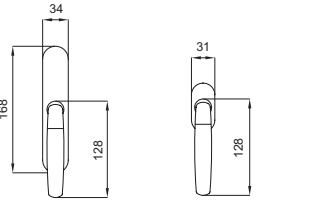
 <p><b>683/5</b></p>	 <p><b>686</b></p>	<p>FINITURE / FINISHES</p>  <p><b>682 - OLS</b></p>  <p><b>683/5 - CCS</b></p>  <p><b>683/2G - CCS</b></p>
 <p><b>680</b></p>	 <p><b>685</b></p>	  <p><b>680</b> Maniglia su placca <i>Door handle on plate</i></p> <p><b>682</b> Maniglia su rosetta e bocchetta ottone 50 mm <i>Door handle on brass rose and escutcheon 50 mm</i></p> <p><b>682/B</b> Maniglia su rosetta e bocchetta ottone bombata 50 mm <i>Door handle on rounded brass rose and escutcheon 50 mm</i></p> <p><b>683</b> Maniglia su rosetta e bocchetta nylon 45 mm <i>Door handle on nylon rose and escutcheon 45 mm</i></p> <p><b>683/5</b> Maniglia su rosetta e bocchetta nylon 50 mm <i>Door handle on nylon rose and escutcheon 50 mm</i></p> <p><b>683/2G</b> Maniglia su rosetta e bocchetta nylon 52 mm con rilievo <i>Door handle on nylon rose and escutcheon 52 mm with relief</i></p> <p><b>684</b> Cremonese con meccanismo <i>Window handle with mechanism</i></p> <p><b>685</b> Martellina con meccanismo q. 7x45 mm <i>Window handle with mechanism and 7x45 mm spindle</i></p> <p><b>686</b> Martellina DK <i>DK window handle</i></p> <p>FINITURE / FINISHES <b>OLS - CCS</b></p>

# NOVA-B

**martinelli**  
HANDLES WITH CARE

DESIGN:  
MAURO RONCHI



**683/2G CCS**

Maniglia su rosetta e bocchetta nylon 52 mm con rilievo  
*Door handle on nylon rose and escutcheon 52 mm with relief*

# NOVA-B

# NOVA-B DUE

ottone stampato a caldo - hot stamped brass

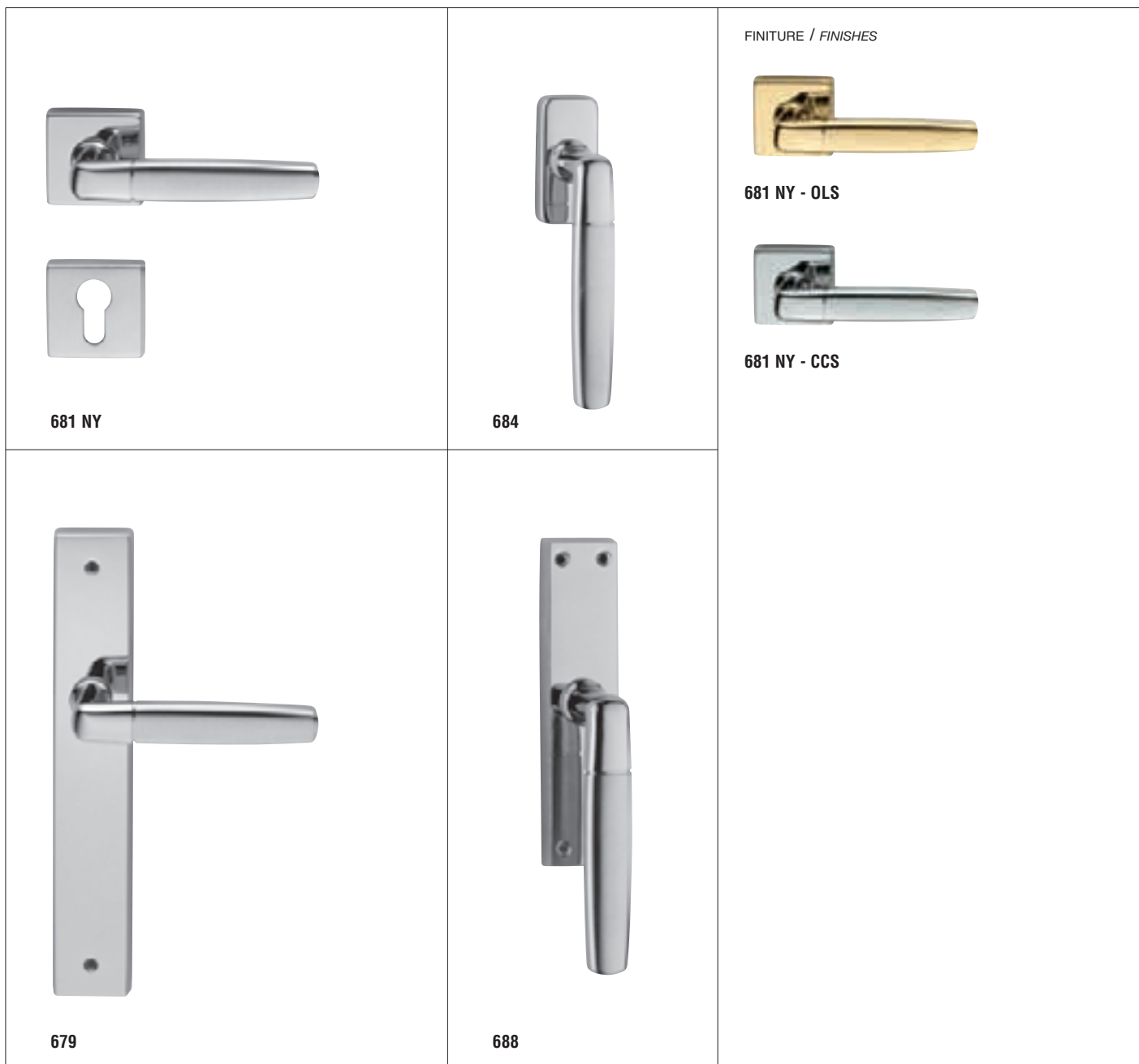

FINITURE / FINISHES



681 NY - OLS



681 NY - CCS

681 NY

684

679

688

**679**  
Maniglia su placca Quadra  
*Door handle on Quadra plate*

**681NY**  
Maniglia su rosetta e bocchetta  
quadra nylon 50 mm  
*Door handle on nylon square rose  
and escutcheon 50 mm*

**687**  
Cremonese con meccanismo  
*Window handle with mechanism*

**688**  
Martellina q.7 senza meccanismo  
*Window handle 7 mm square  
without mechanism*

**684**  
Martellina DK quadro  
*Square DK window handle*

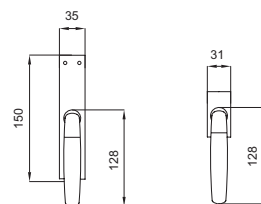
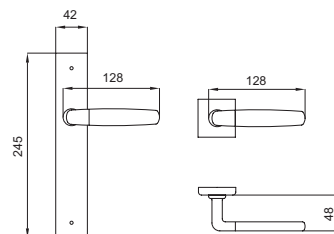

FINITURE / FINISHES  
OLS - CCS

# NOVA-B DUE

**martinelli**  
HANDLES WITH CARE

DESIGN:  
MAURO RONCHI



**681 NY - CCS**

Maniglia su rosetta e bocchetta quadra nylon 50 mm

*Door handle on nylon square rose and escutcheon 50 mm*

NOVA-B DUE

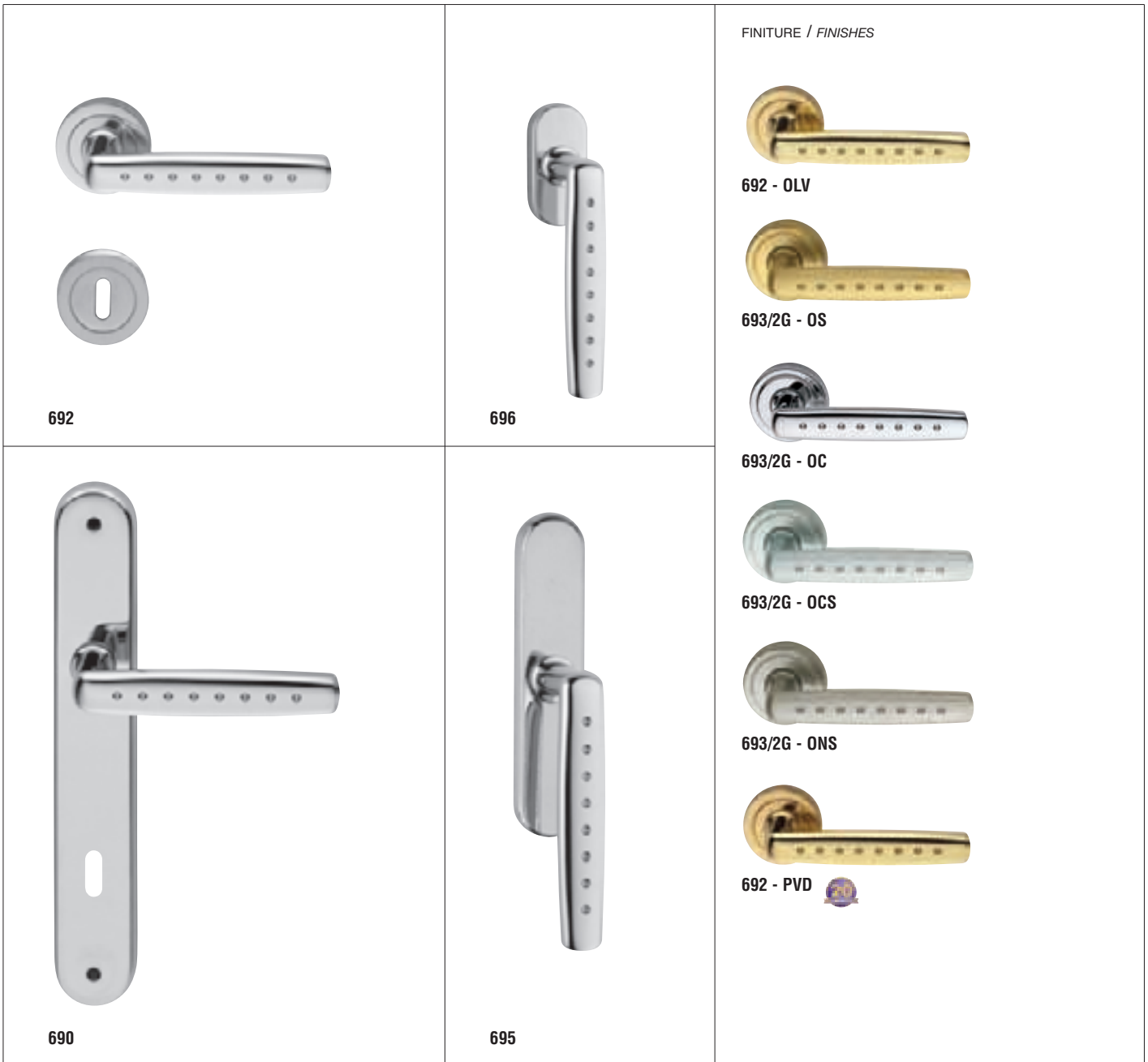

FINITURE / FINISHES

- 692 - OLV
- 693/2G - OS
- 693/2G - OC
- 693/2G - OCS
- 693/2G - ONS
- 692 - PVD

**690**  
Maniglia su placca  
*Door handle on plate*

**692**  
Maniglia su rosetta e bocchetta  
ottone 50 mm  
*Door handle on brass rose  
and escutcheon 50 mm*

**692/B**  
Maniglia su rosetta e bocchetta  
ottone bombata 50 mm  
*Door handle on rounded brass rose  
and escutcheon 50 mm*

**693**  
Maniglia su rosetta e bocchetta  
nylon 45 mm  
*Door handle on nylon rose  
and escutcheon 45 mm*

**693/5**  
Maniglia su rosetta e bocchetta  
nylon 50 mm  
*Door handle on nylon rose  
and escutcheon 50 mm*

**693/2G**  
Maniglia su rosetta e bocchetta  
nylon 52 mm con rilievo  
*Door handle on nylon rose  
and escutcheon 52 mm with relief*

**694**  
Cremonese con meccanismo  
*Window handle with mechanism*

**695**  
Martellina con meccanismo  
q. 7x45 mm  
*Window handle with mechanism  
and 7x45 mm spindle*

**696**  
Martellina DK  
*DK window handle*

FINITURE / FINISHES  
**OLV - OS - OC - OCS - ONS**  
**PVD - PVD INOX**

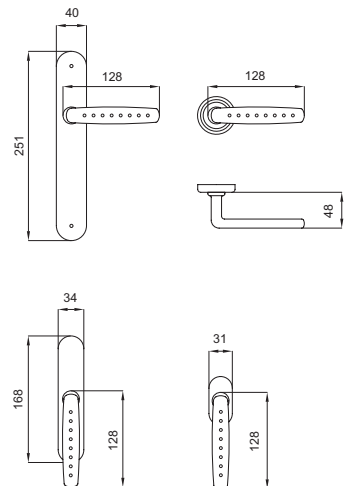

# NOVA-C

**martinelli**  
HANDLES WITH CARE

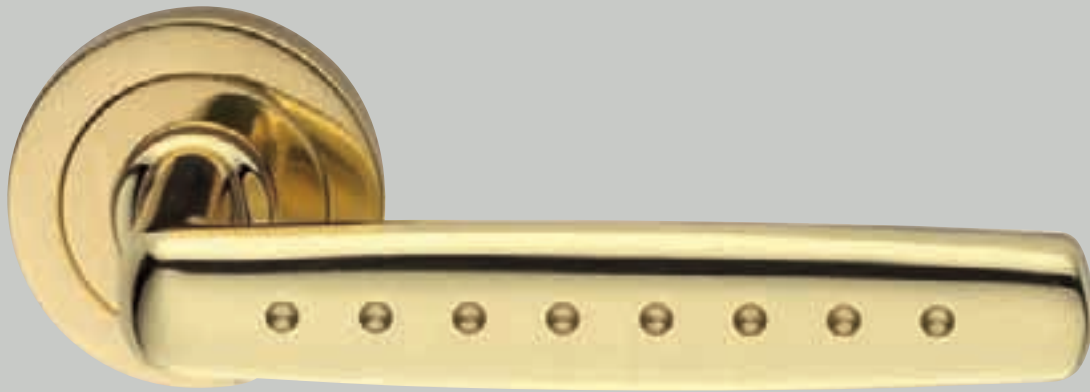

**692 OLV**

Maniglia su rosetta e bocchetta ottone 50 mm  
*Door handle on brass rose and escutcheon 50 mm*

DESIGN:  
MAURO RONCHI

# NOVA-C

# NOVA-C DUE

ottone stampato a caldo - hot stamped brass



691 NY

694

FINITURE / FINISHES



691 NY - OLV



691 NY - OS



691 NY - OC



691 NY - OCS



691 NY - ONS



691 NY - PVD



691 NY - PVD INOX

689

698

**689**  
Maniglia su placca Quadra  
*Door handle on Quadra plate*

**691NY**  
Maniglia su rosetta e bocchetta  
quadra nylon 50 mm  
*Door handle on nylon square rose  
and escutcheon 50 mm*

**697**  
Cremonese con meccanismo  
*Window handle with mechanism*

**698**  
Martellina q.7 senza meccanismo  
*Window handle 7 mm square  
without mechanism*

**694**  
Martellina DK quadro  
*Square DK window handle*

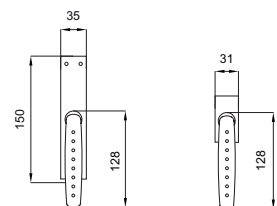
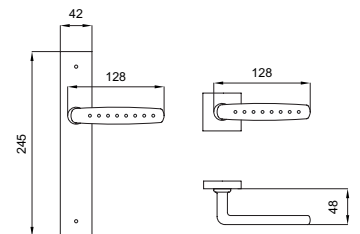

FINITURE / FINISHES  
OLV - OS - OC - OCS - ONS  
PVD - PVD INOX



# NOVA-C DUE

**martinelli**  
HANDLES WITH CARE

DESIGN:  
MAURO RONCHI



**691NY OCS**

Maniglia su rosetta e bocchetta quadra nylon 50 mm

*Door handle on nylon square rose and escutcheon 50 mm*

# NOVA-C DUE

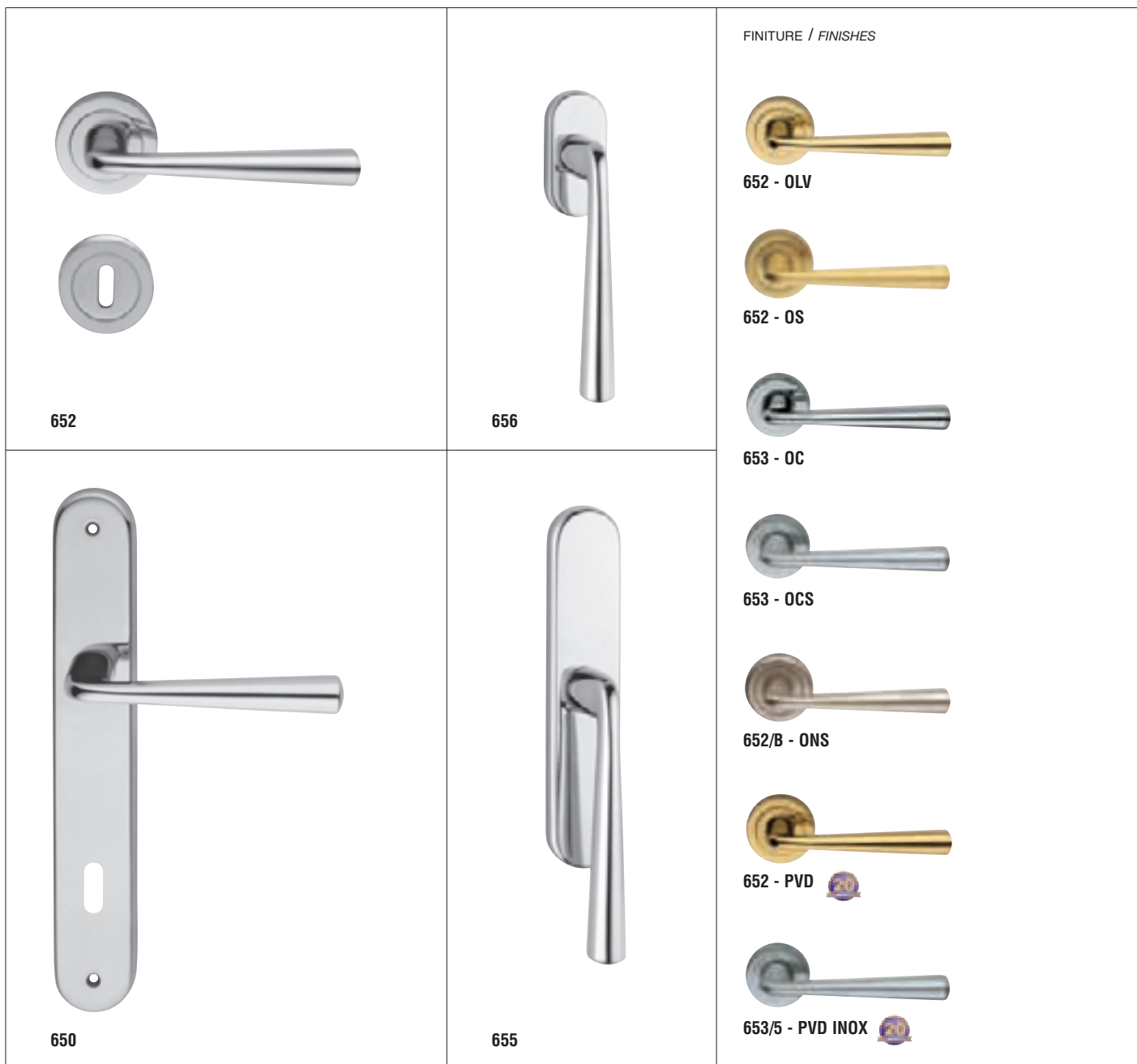

**650**  
Maniglia su placca  
*Door handle on plate*

**652**  
Maniglia su rosetta e bocchetta  
ottone 50 mm  
*Door handle on brass rose  
and escutcheon 50 mm*

**652/B**  
Maniglia su rosetta e bocchetta  
ottone bombata 50 mm  
*Door handle on rounded brass rose  
and escutcheon 50 mm*

**653**  
Maniglia su rosetta e bocchetta  
nylon 45 mm  
*Door handle on nylon rose  
and escutcheon 45 mm*

**653/5**  
Maniglia su rosetta e bocchetta  
nylon 50 mm  
*Door handle on nylon rose  
and escutcheon 50 mm*

**653/2G**  
Maniglia su rosetta e bocchetta  
nylon 52 mm con rilievo  
*Door handle on nylon rose  
and escutcheon 52 mm with relief*

**654**  
Cremonese con meccanismo  
*Window handle with mechanism*

**655**  
Martellina con meccanismo  
q. 7x45 mm  
*Window handle with mechanism  
and 7x45 mm spindle*

**656**  
Martellina DK  
*DK window handle*

FINITURE / FINISHES  
**OLV - OS - OC - OCS - ONS  
PVD - PVD INOX**

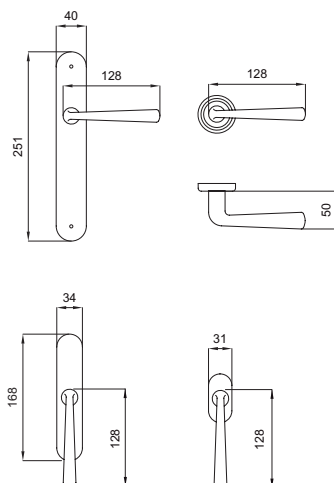

# LINK

**martinelli**  
HANDLES WITH CARE

DESIGN:  
MAURO RONCHI

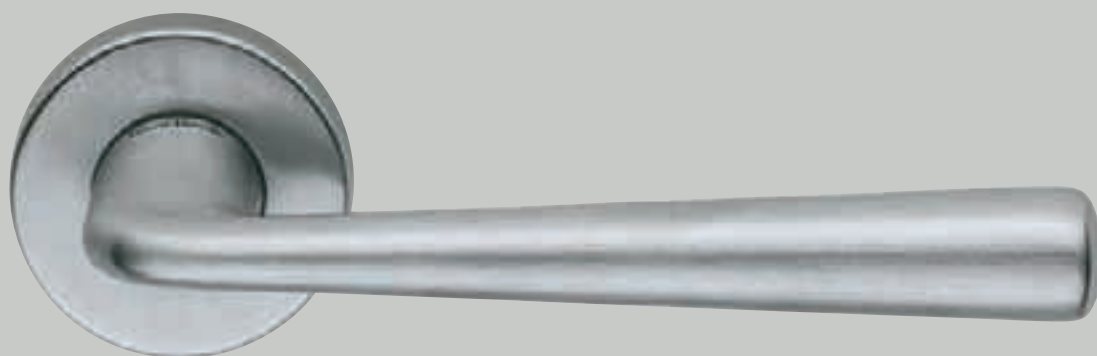

**653 OCS**

Maniglia su rosetta e bocchetta nylon 45 mm

*Door handle on nylon rose and escutcheon 45 mm*

# LINK

 <p><b>651 NY</b></p>	 <p><b>648</b></p>	<p>FINITURE / FINISHES</p>  <p><b>651 NY - OLV</b></p>  <p><b>651 NY - OS</b></p>  <p><b>651 NY - OC</b></p>
 <p><b>649</b></p>	 <p><b>658</b></p>	 <p><b>651 NY - OCS</b></p>  <p><b>651 NY - ONS</b></p>  <p><b>651 NY - PVD</b></p>  <p><b>651 NY - PVD INOX</b></p>

**649**  
maniglia su placca Quadra  
*door handle on Quadra plate*

**651NY**  
maniglia su rosetta e bocchetta  
quadra nylon 50 mm  
*door handle on nylon square rose  
and escutcheon 50 mm*

**657**  
cremonese con meccanismo  
*window handle with mechanism*

**658**  
martellina q.7 senza meccanismo  
*window handle 7 mm square  
without mechanism*

**648**  
martellina DK quadro  
*square DK window handle*

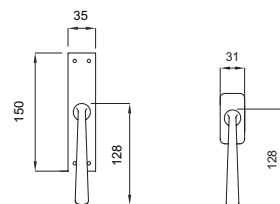
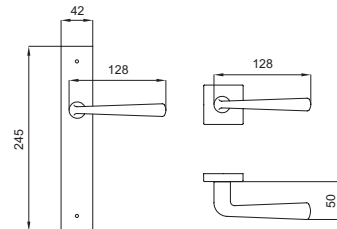

FINITURE / FINISHES  
**OLV - OS - OC - OCS - ONS**  
**PVD - PVD INOX**

# LINK DUE

**martinelli**  
HANDLES WITH CARE

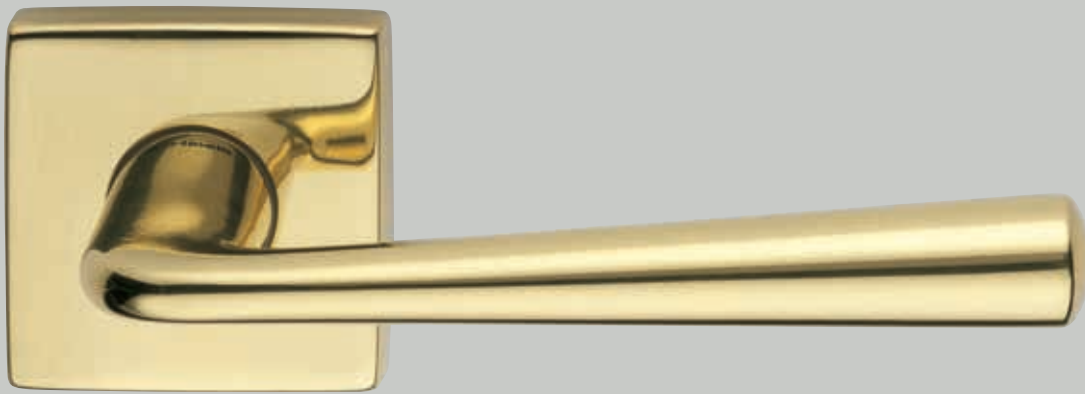

**651NY OLV**

Maniglia su rosetta e bocchetta quadra nylon 50 mm

*Door handle on nylon square rose and escutcheon 50 mm*

DESIGN:  
MAURO RONCHI

# LINK DUE

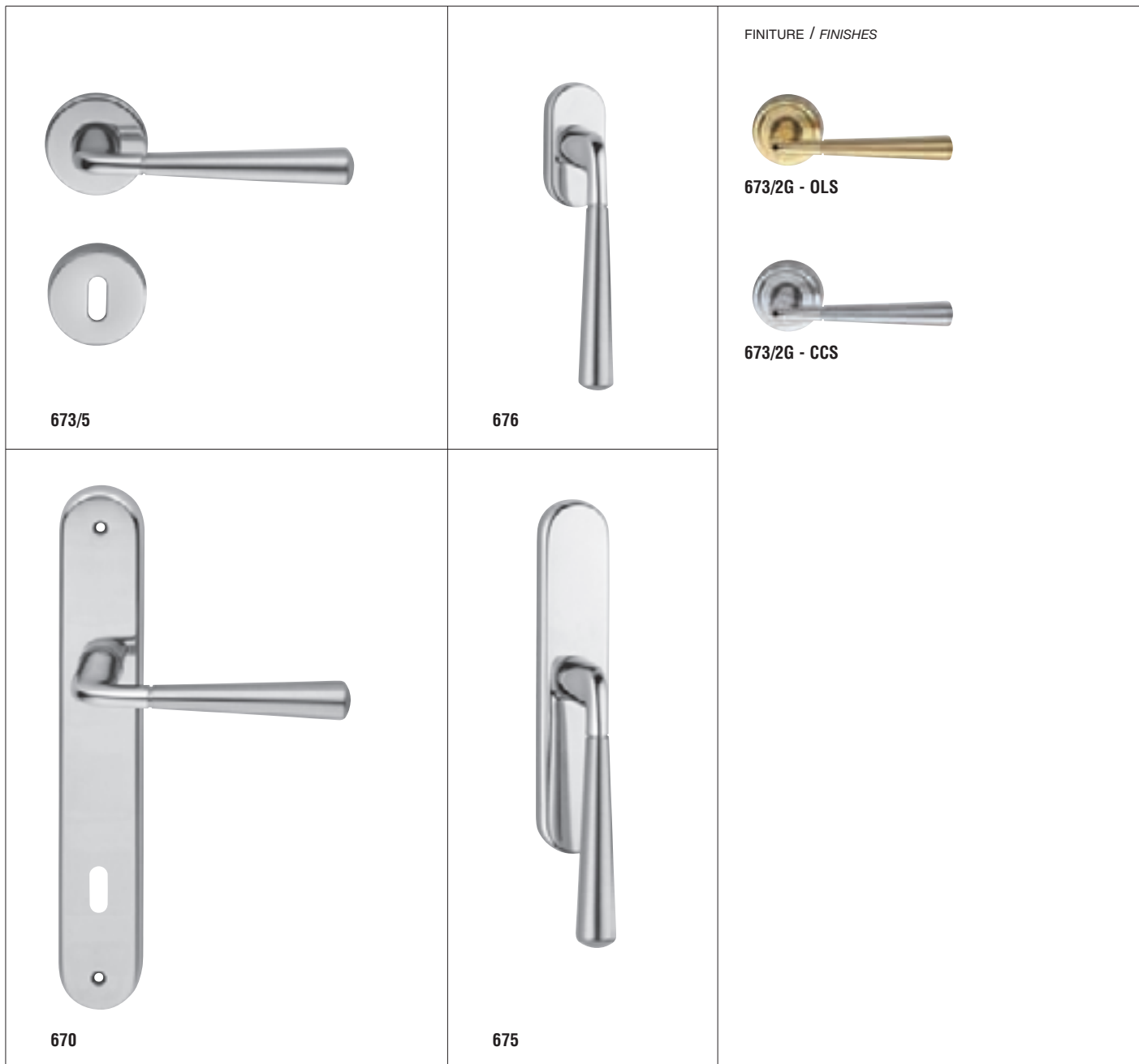

FINITURE / FINISHES



673/2G - OLS



673/2G - CCS

**670**

Maniglia su placca  
*Door handle on plate*

**672**

Maniglia su rosetta e bocchetta  
ottone 50 mm  
*Door handle on brass rose  
and escutcheon 50 mm*

**672/B**

Maniglia su rosetta e bocchetta  
ottone bombata 50 mm  
*Door handle on rounded brass rose  
and escutcheon 50 mm*

**673**

Maniglia su rosetta e bocchetta  
nylon 45 mm  
*Door handle on nylon rose  
and escutcheon 45 mm*

**673/5**

Maniglia su rosetta e bocchetta  
nylon 50 mm  
*Door handle on nylon rose  
and escutcheon 50 mm*

**673/2G**

Maniglia su rosetta e bocchetta  
nylon 52 mm con rilievo  
*Door handle on nylon rose and  
escutcheon 52 mm with relief*

**674**

Cremonese con meccanismo  
*Window handle with mechanism*

**675**

Martellina con meccanismo  
q. 7x45 mm  
*Window handle with mechanism  
and 7x45 mm spindle*

**676**

Martellina DK  
*DK window handle*

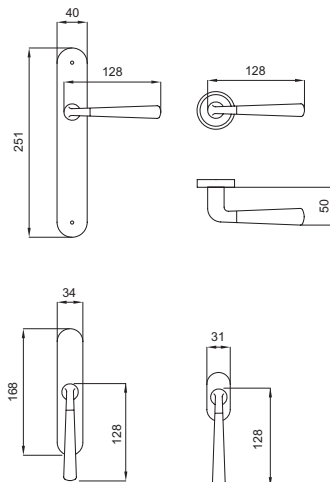

FINITURE / FINISHES

OLS - CCS

# LINK-B

**martinelli**  
HANDLES WITH CARE

DESIGN:  
MAURO RONCHI







**673/2G OLS**

Maniglia su rosetta e bocchetta nylon 52 mm con rilievo  
*Door handle on nylon rose and escutcheon 52 mm with relief*

# LINK-B

# LINK-B DUE

ottone stampato a caldo - hot stamped brass

 <p><b>671 NY</b></p>	 <p><b>678DK</b></p>	<p>FINITURE / FINISHES</p>  <p><b>671 NY - OLS</b></p>  <p><b>671 NY - CCS</b></p>
 <p><b>669</b></p>	 <p><b>678</b></p>	

**669**  
Maniglia su placca Quadra  
*Door handle on Quadra plate*

**671NY**  
Maniglia su rosetta e bocchetta  
quadra nylon 50 mm  
*Door handle on nylon square rose  
and escutcheon 50 mm*

**677**  
Cremonese con meccanismo  
*Window handle with mechanism*

**678**  
Martellina q.7 senza meccanismo  
*Window handle 7 mm square  
without mechanism*

**678 DK**  
Martellina DK quadro  
*Square DK window handle*

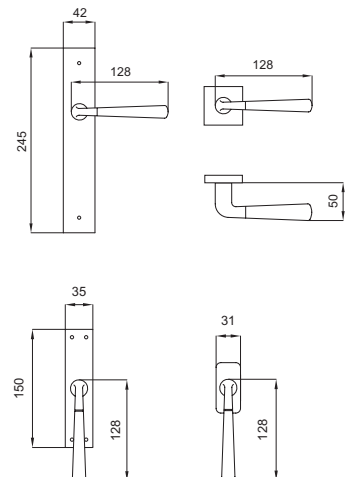

FINITURE / FINISHES  
**OLS - CCS**



# LINK-B DUE

**martinelli**  
HANDLES WITH CARE

DESIGN:  
MAURO RONCHI



**671NY CCS**

Maniglia su rosetta e bocchetta quadra nylon 50 mm

*Door handle on nylon square rose and escutcheon 50 mm*

LINK-B DUE



**600**  
Maniglia su placca Noxia  
*Door handle on Noxia plate*

**601**  
Maniglia su placca Cometa  
*Door handle on Cometa plate*

**604/B**  
Maniglia su rosetta e bocchetta  
ottone bombata 50 mm  
*Door handle on rounded brass  
rose and escutcheon 50 mm*

**603/5**  
Maniglia su rosetta  
e bocchetta nylon 50 mm  
*Door handle on nylon rose  
and escutcheon 50 mm*

**707**  
Cremonese con meccanismo  
*Window handle with mechanism*

**708**  
Martellina con meccanismo  
q. 7x45 mm  
*Window handle with mechanism  
and 7x45 mm spindle*

**605**  
Martellina DK  
*DK window handle*

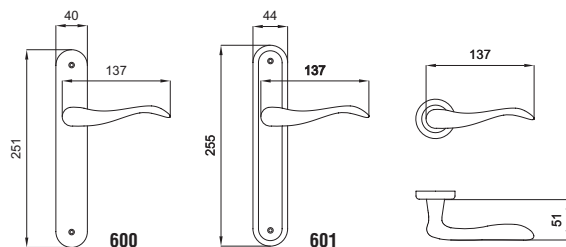

FINITURE / FINISHES  
OLV - OS - AB - OGC - OGH  
OC - OCS - FAN - SIL

# AIRONE

**martinelli**  
HANDLES WITH CARE



**604/B OLV**

Maniglia su rosetta e bocchetta ottone bombata 50 mm  
*Door handle on rounded brass rose and escutcheon 50 mm*

DESIGN:  
MAURO RONCHI

# AIRONE



FINITURE / FINISHES



622/B - OLV



623/5 - OS



623/5 - OGC



623 - OC



622/B - OCS



623 - ONS

**620**

Maniglia su placca Sabina  
*Door handle on Sabina plate*

**624**

Maniglia su placca Arcadia  
*Door handle on Arcadia plate*

**622/B**

Maniglia su rosetta e bocchetta  
ottone bombata 50 mm  
*Door handle on rounded brass rose  
and escutcheon 50 mm*

**623**

Maniglia su rosetta e bocchetta  
nylon 45 mm  
*Door handle on nylon rose  
and escutcheon 45 mm*

**623/5**

Maniglia su rosetta e bocchetta  
nylon 50 mm  
*Door handle on nylon rose  
and escutcheon 50 mm*

**283**

Cremonese con meccanismo  
*Window handle with mechanism*

**285**

Martellina q.7 senza meccanismo  
*Window handle 7 mm square  
without mechanism*

**625NY**

Martellina DK con meccanismo nylon  
*DK window handle with nylon  
mechanism*

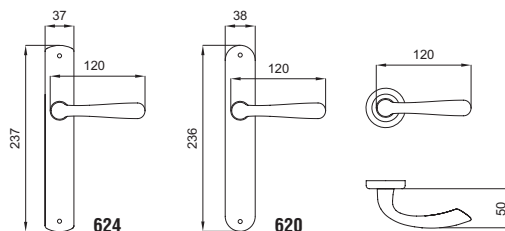

624

620

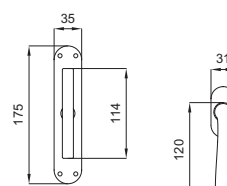

FINITURE / FINISHES

OLV - OS - OGC - OC  
OCS - ONS

# HANDY

**martinelli**  
HANDLES WITH CARE



**623 OC**

Maniglia su rosetta e bocchetta nylon 45 mm  
*Door handle on nylon rose and escutcheon 45 mm*

DESIGN:  
MAURO RONCHI

# HANDY



632/B

635 NY

FINITURE / FINISHES

633 - OLV

633/5 - OS

633 - OGC

632/B - OC

632/B - OCS

633 - ONS

**630**

Maniglia su placca Sabina  
*Door handle on Sabina plate*

**634**

Maniglia su placca Arcadia  
*Door handle on Arcadia plate*

**632/B**

Maniglia su rosetta e bocchetta  
ottone bombata 50 mm  
*Door handle on rounded brass rose  
and escutcheon 50 mm*

**633**

Maniglia su rosetta e bocchetta  
nylon 45 mm  
*Door handle on nylon rose  
and escutcheon 45 mm*

**633/5**

Maniglia su rosetta e bocchetta  
nylon 50 mm  
*Door handle on nylon rose  
and escutcheon 50 mm*

**703**

Cremonese con meccanismo  
*Window handle with mechanism*

**704**

Martellina q.7 senza meccanismo  
*Window handle 7 mm square  
without mechanism*

**635NY**

Martellina DK con meccanismo nylon  
*DK window handle with nylon  
mechanism*

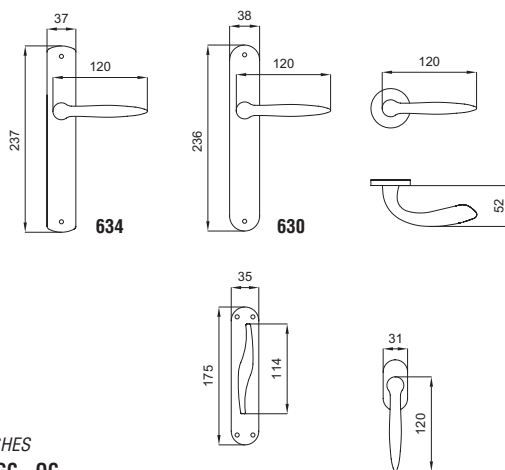

FINITURE / FINISHES  
OLV - OS - OGC - OC  
OCS - ONS

# FAST

**martinelli**  
HANDLES WITH CARE



**632/B OCS**

Maniglia su rosetta e bocchetta ottone bombata 50 mm  
*Door handle on rounded brass rose and escutcheon 50 mm*

DESIGN:  
MAURO RONCHI

# FAST

 <p><b>142/B</b></p>	 <p><b>146</b></p>	<p>FINITURE / FINISHES</p>  <p><b>142/B - OLV</b></p>  <p><b>142/B - OS</b></p>  <p><b>142/B - OGC</b></p>  <p><b>142/B - OGH</b></p>  <p><b>142/B - PVD</b></p>  <p><b>142/B - PVD INOX</b></p>
 <p><b>140</b></p>		

**140**  
 Maniglia su placca  
 Door handle on plate

**142/B**  
 Maniglia su rosetta e bocchetta  
 ottone bombata 50 mm  
 Door handle on rounded brass rose  
 and escutcheon 50 mm

**146**  
 Martellina DK  
 DK window handle

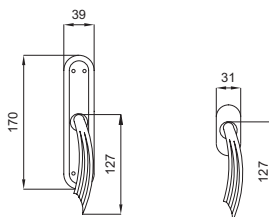
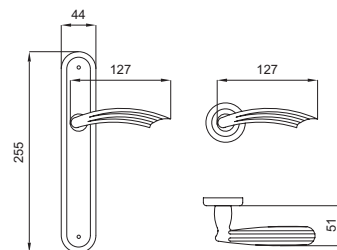

FINITURE / FINISHES  
**OLV - OS - OGC - OGH - FAN**  
**SIL - PVD - PVD INOX**



# BEVERLY

**martinelli**  
HANDLES WITH CARE



**142/B OLV**

Maniglia su rosetta e bocchetta ottone bombata 50 mm  
*Door handle on rounded brass rose and escutcheon 50 mm*

DESIGN:  
MAURO RONCHI

# BEVERLY

# VENICE

Materiale: ottone - solid brass



FINITURE / FINISHES



191 - OLS



191 - LPA



191 - CCS



191 - CNS



191 - CMU



191 - NPA

191

194

190

193

**190**  
Maniglia su placca  
*Door handle on plate*

**191**  
Maniglia su rosetta Venice  
e bocchetta ottone 50 mm  
*Door handle on Venice brass rose  
and escutcheon 50 mm*

**192**  
Cremonese con meccanismo  
*Window handle with mechanism*

**193**  
Martellina con meccanismo  
q. 7x45 mm  
*Window handle with mechanism  
and 7x45 mm spindle*

**194**  
Martellina DK  
*DK window handle*

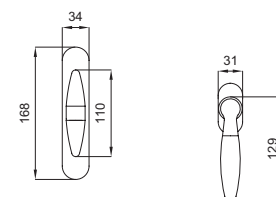
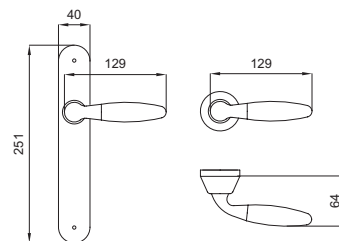

FINITURE / FINISHES  
OLS - LPA - CCS - CNS  
CMU - NPA

# VENICE

**martinelli**  
HANDLES WITH CARE

DESIGN:  
PIETRO SILVA



**191 NPA**

Maniglia su rosetta Venice e bocchetta ottone 50 mm

*Door handle on Venice brass rose and escutcheon 50 mm*

# VENICE

# VENICE DUE

Materiale: ottone - solid brass



FINITURE / FINISHES



196 - OLS



196 - CCS



196 - CNS



196 - CMU

**190**  
Maniglia su placca  
*Door handle on plate*

**196**  
Maniglia Venice Due su rosetta  
e bocchetta ottone 50 mm  
*Venice Due door handle on brass  
rose and escutcheon 50 mm*

**192**  
Cremonese con meccanismo  
*Window handle with mechanism*

**193**  
Martellina con meccanismo  
q. 7x45 mm  
*Window handle with mechanism  
and 7x45 mm spindle*

**194**  
Martellina DK  
*DK window handle*

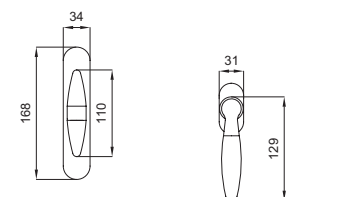
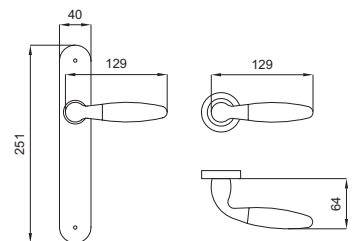

FINITURE / FINISHES  
OLS - LPA - CCS - CNS  
CMU - NPA

# VENICE DUE

**martinelli**  
HANDLES WITH CARE



**196 CCS**

Maniglia su rosetta e bocchetta ottone 50 mm  
*Door handle on brass rose and escutcheon 50 mm*

DESIGN:  
PIETRO SILVA

# VENICE DUE

# ROUND

Materiale: ottone - solid brass



FINITURE / FINISHES



710 - OLS



710 - CCS



711 - OLS

**713**  
Maniglia su placca  
*Door handle on plate*

**710**  
Maniglia su rosetta Venice  
e bocchetta ottone 50 mm  
*Door handle on Venice brass rose  
and escutcheon 50 mm*

**711**  
Maniglia su rosetta e bocchetta  
ottone 50 mm  
*Door handle on brass rose  
and escutcheon 50 mm*

**712**  
Martellina DK  
*DK window handle*

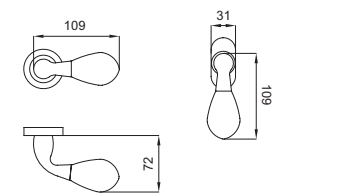
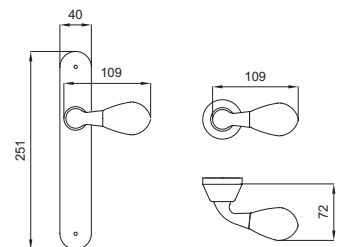

FINITURE / FINISHES  
OLS - CCS  
PVD - PVD INOX

# ROUND



**711 OLS**

Maniglia su rosetta e bocchetta ottone 50 mm

*Door handle on brass rose and escutcheon 50 mm*

# ROUND

# BOOMERANG

ottone stampato a caldo - hot stamped brass

**martinelli**  
HANDLES WITH CARE



**180**  
Maniglia su placca  
*Door handle on plate*

**181/B**  
Maniglia su rosetta e bocchetta  
ottone bombata 50 mm  
*Door handle on rounded brass rose  
and escutcheon 50 mm*

**181**  
Maniglia su rosetta e bocchetta  
ottone 55 mm  
*Door handle on brass rose  
and escutcheon 55 mm*

**182**  
Cremonese con meccanismo  
*Window handle with mechanism*

**183**  
Martellina q.7 senza meccanismo  
*Window handle 7 mm square  
without mechanism*

**184**  
Martellina DK  
*DK window handle*

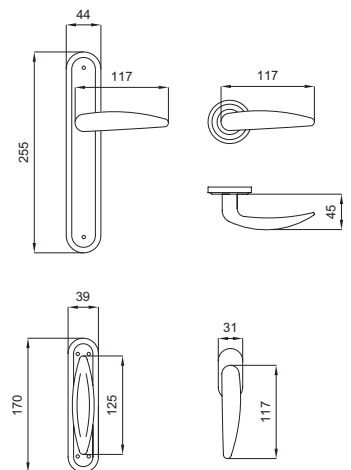

FINITURE / FINISHES  
OLV - OC - OCS  
PVD - PVD INOX



# BOOMERANG

**martinelli**  
HANDLES WITH CARE



**181 OLV**

Maniglia su rosetta e bocchetta ottone 55 mm

*Door handle on brass rose and escutcheon 55 mm*

DESIGN:  
EMILIO CUPOLO

# BOOMERANG

# COTTAGE

Materiale: ottone - solid brass

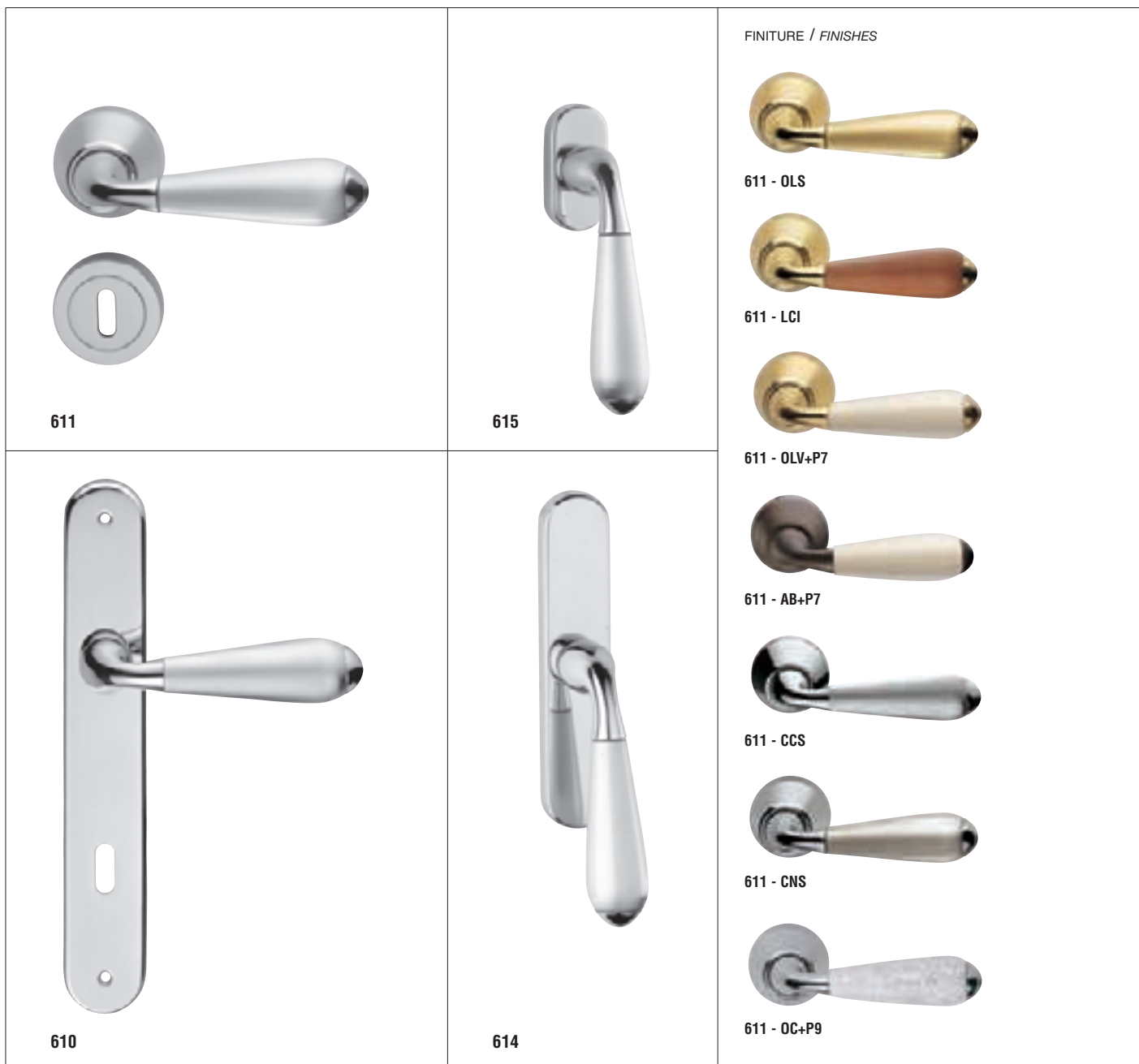

FINITURE / FINISHES



611 - OLS



611 - LCI



611 - OLV+P7



611 - AB+P7



611 - CCS



611 - CNS

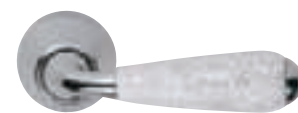

611 - OC+P9

**610**  
Maniglia su placca  
*Door handle on plate*

**611**  
Maniglia su rosetta Venice e  
bocchetta ottone 50 mm  
*Door handle on Venice brass rose  
and escutcheon 50 mm*

**613**  
Cremonese con meccanismo  
*Window handle with mechanism*

**614**  
Martellina con meccanismo  
q. 7x45 mm.  
*window handle with mechanism and  
7x45 mm spindle*

**615**  
Martellina DK  
*DK window handle*

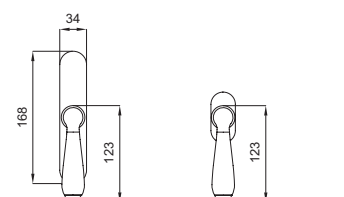
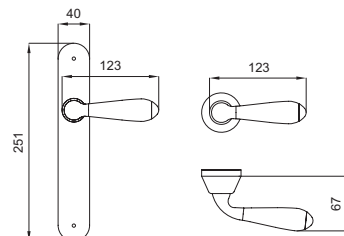

FINITURE / FINISHES  
OLS - CCS - CNS - LCI  
SCI - OLV+P7 - AB+P7 - AB+P8  
OC+P9 - ONS+P9

# COTTAGE

**martinelli**  
HANDLES WITH CARE

DESIGN:  
MARTINELLI LAB



**611 CNS**

Maniglia su rosetta Venice e bocchetta ottone 50 mm

*Door handle on Venice brass rose and escutcheon 50 mm*

# COTTAGE

# COTTAGE DUE

Materiale: ottone - solid brass



**610**  
Maniglia su placca  
*Door handle on plate*

**612**  
Maniglia su rosetta e bocchetta  
ottone 50 mm  
*Door handle on brass rose  
and escutcheon 50 mm*

**613**  
Cremonese con meccanismo  
*Window handle with mechanism*

**614**  
Martellina con meccanismo  
q. 7x45 mm.  
*Window handle with mechanism  
and 7x45 mm spindle*

**615**  
Martellina DK  
*DK window handle*

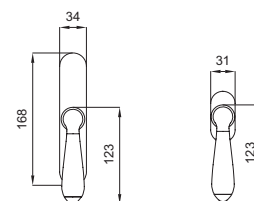
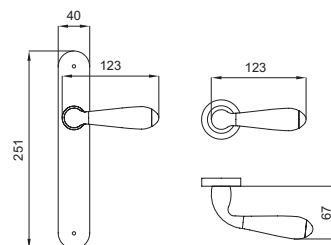

FINITURE / FINISHES  
**OLS** - **CCS** - **CNS** - **LC**  
**SCI** - **OLV+P7** - **AB+P7** - **AB+P8**  
**OC+P9** - **ONS+P9**

# COTTAGE DUE

**martinelli**  
HANDLES WITH CARE



**612 OLS**

Maniglia su rosetta e bocchetta ottone 50 mm

*Door handle on brass rose and escutcheon 50 mm*

DESIGN:  
MARTINELLI LAB

# COTTAGE DUE

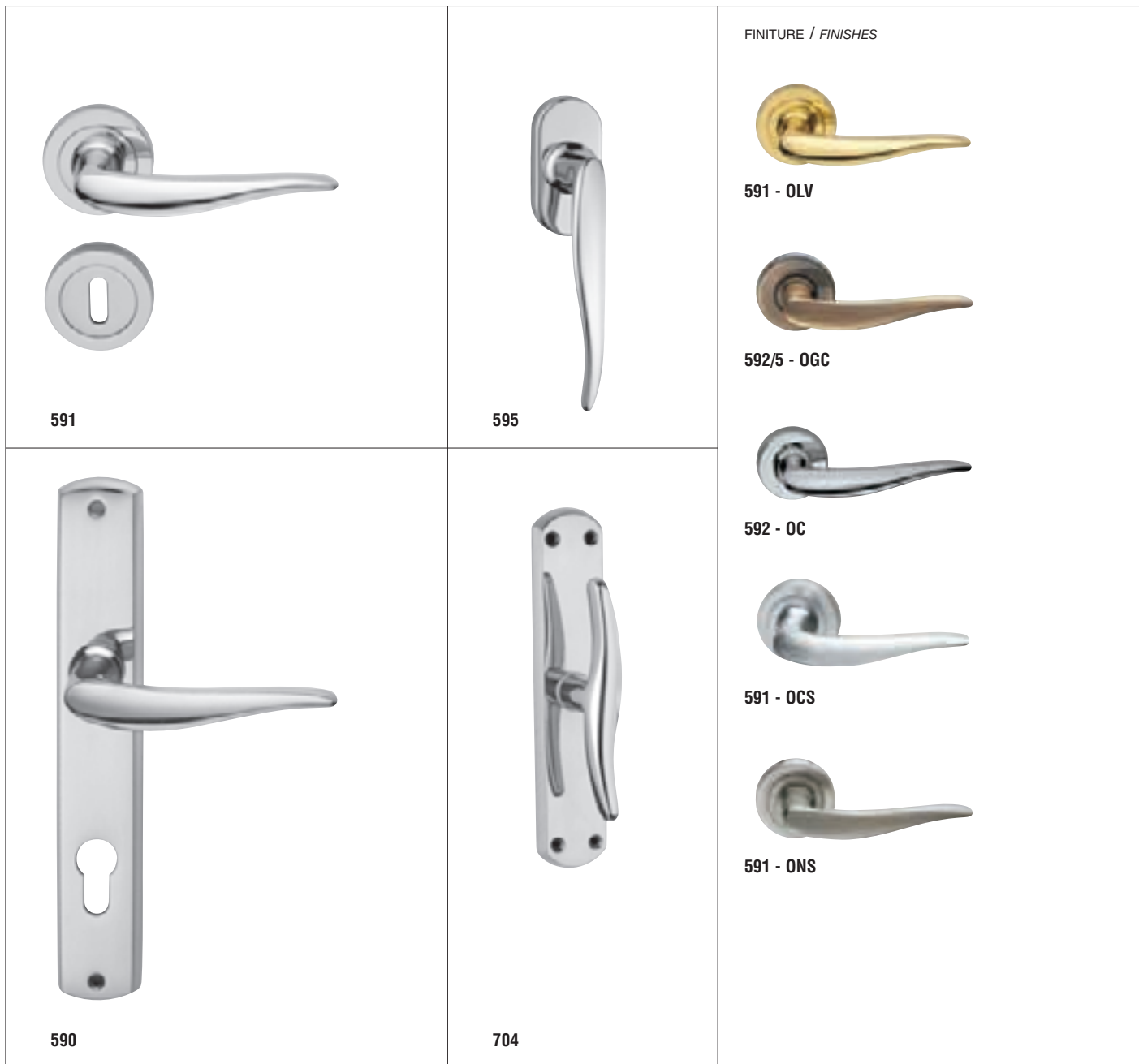

FINITURE / FINISHES



591 - OLV



592/5 - OGC



592 - OC



591 - OCS



591 - ONS

591

595

590

704

**590**  
Maniglia su placca  
*Door handle on plate*

**591**  
Maniglia su rosetta e bocchetta  
ottone 50 mm  
*Door handle on brass rose  
and escutcheon 50 mm*

**592**  
Maniglia su rosetta e bocchetta  
nylon 45 mm  
*Door handle on nylon rose  
and escutcheon 45 mm*

**592/5**  
Maniglia su rosetta  
e bocchetta nylon 50 mm  
*Door handle on nylon rose  
and escutcheon 50 mm*

**703**  
Cremonese con meccanismo  
*Window handle with mechanism*

**704**  
Martellina q.7 senza meccanismo  
*Window handle 7 mm square  
without mechanism*

**595**  
Martellina DK  
*DK window handle*

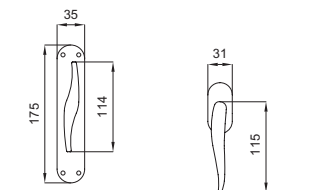
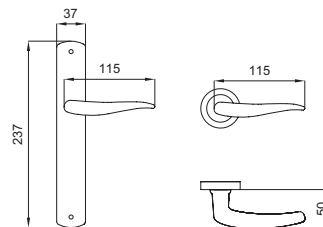

FINITURE / FINISHES  
OLV - OGC - OC - OCS - ONS

# ARCADIA

**martinelli**  
HANDLES WITH CARE



**592 OC**

Maniglia su rosetta e bocchetta nylon 45 mm  
*Door handle on nylon rose and escutcheon 45 mm*

DESIGN:  
MAURO RONCHI

# ARCADIA



152/5

157

FINITURE / FINISHES

152/5 - OLV

152/5 - OC

151 - OCS

151 - ONS

150

156

**149**  
maniglia su placca Quadra  
*door handle on Quadra plate*

**150**  
maniglia su placca Noxia  
*door handle on Noxia plate*

**151**  
maniglia su rosetta e bocchetta  
ottone 50 mm  
*door handle on brass rose  
and escutcheon 50 mm*

**152/5**  
maniglia su rosetta e bocchetta  
nylon 50 mm  
*door handle on nylon rose  
and escutcheon 50 mm*

**154**  
cremonese con meccanismo  
*window handle with mechanism*

**156**  
martellina con meccanismo  
q. 7x45 mm  
*window handle with mechanism  
and 7x45 mm spindle*

**157**  
martellina DK  
*DK window handle*

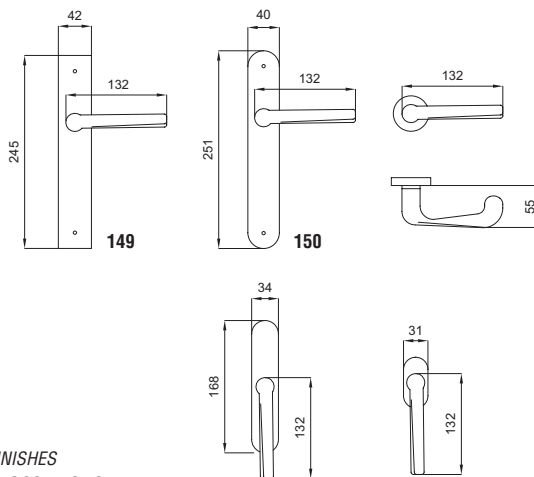

FINITURE / FINISHES  
OLV - OC - OCS - ONS



# TECHNA

**martinelli**  
HANDLES WITH CARE



**151 OCS**

Maniglia su rosetta e bocchetta ottone 50 mm  
*Door handle on brass rose and escutcheon 50 mm*

DESIGN:  
PIETRO SILVA

# TECHNA



**159**  
Maniglia su placca Quadra  
*Door handle on Quadra plate*

**160**  
Maniglia su placca Noxia  
*Door handle on Noxia plate*

**161**  
Maniglia su rosetta e bocchetta  
ottone 50 mm  
*Door handle on brass rose  
and escutcheon 50 mm*

**162/5**  
Maniglia su rosetta e bocchetta  
nylon 50 mm  
*Door handle on nylon rose  
and escutcheon 50 mm*

**164**  
Cremonese con meccanismo  
*Window handle with mechanism*

**166**  
Martellina con meccanismo  
q. 7x45 mm  
*Window handle with mechanism  
and 7x45 mm spindle*

**167**  
Martellina DK  
*DK window handle*

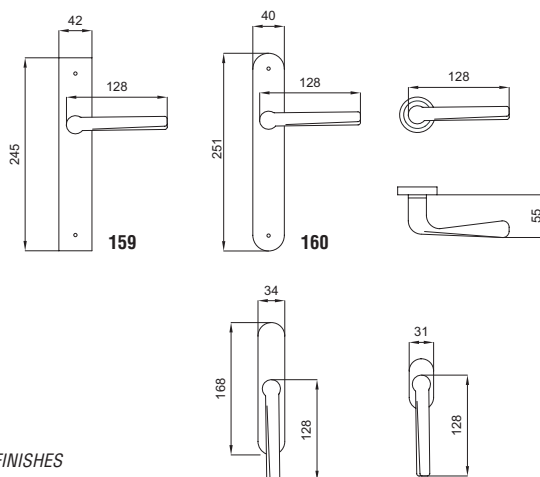

FINITURE / FINISHES  
OLV - OS - OC - OCS

# TESA

**martinelli**  
HANDLES WITH CARE













**161 OLV**

Maniglia su rosetta e bocchetta ottone 50 mm  
*Door handle on brass rose and escutcheon 50 mm*

DESIGN:  
PIETRO SILVA

# TESA

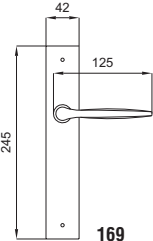
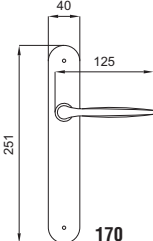
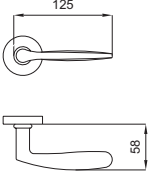
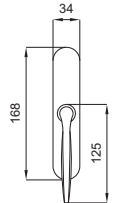
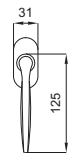
  <p><b>172/5</b></p>	 <p><b>177</b></p>	<p>FINITURE / FINISHES</p>  <p><b>172/5 - OLV</b></p>  <p><b>171 - OS</b></p>  <p><b>172/5 - OC</b></p>  <p><b>171 - OCS</b></p>  <p><b>171 - ONS</b></p>
 <p><b>170</b></p>	 <p><b>176</b></p>	     <p>FINITURE / FINISHES OLV - OS - OC - OCS - ONS</p>
<p><b>169</b> Maniglia su placca Quadra <i>Door handle on Quadra plate</i></p> <p><b>170</b> Maniglia su placca Noxia <i>Door handle on Noxia plate</i></p> <p><b>171</b> Maniglia su rosetta e bocchetta ottone 50 mm <i>Door handle on brass rose and escutcheon 50 mm</i></p> <p><b>172/5</b> Maniglia su rosetta e bocchetta nylon 50 mm <i>Door handle on nylon rose and escutcheon 50 mm</i></p>	<p><b>174</b> Cremonese con meccanismo <i>Window handle with mechanism</i></p> <p><b>176</b> Martellina con meccanismo q. 7x45 mm <i>Window handle with mechanism and 7x45 mm spindle</i></p> <p><b>177</b> Martellina DK <i>DK window handle</i></p>	

# TIPO

**martinelli**  
HANDLES WITH CARE

DESIGN:  
PIETRO SILVA



**171 ONS**

Maniglia su rosetta e bocchetta ottone 50 mm  
*Door handle on brass rose and escutcheon 50 mm*

# TIPO



FINITURE / FINISHES



201 - OLV



201 - ONS



201 - ORO



201 - ORA



201 - PVD

**200**  
Maniglia su placca  
*Door handle on plate*

**201/B**  
Maniglia su rosetta e bocchetta  
ottone bombata 50 mm  
*Door handle on rounded brass  
rose and escutcheon 50 mm*

**201**  
Maniglia su rosetta e bocchetta  
ottone 55 mm  
*Door handle on brass rose  
and escutcheon 55 mm*

**202**  
Cremonese con meccanismo  
*Window handle with mechanism*

**203**  
Martellina q.7 senza meccanismo  
*Window handle 7 mm square  
without mechanism*

**204**  
Martellina DK  
*DK window handle*

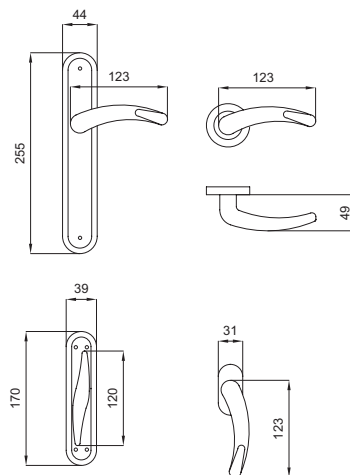

FINITURE / FINISHES  
OLV - ONS - ORO - ORA - PVD

# COMETA

**martinelli**  
HANDLES WITH CARE

DESIGN:  
EMILIO CUPOLO



**201 OLV**

Maniglia su rosetta e bocchetta ottone 55 mm  
*Door handle on brass rose and escutcheon 55 mm*

# COMETA



**210**  
Maniglia su placca  
*Door handle on plate*

**211/B**  
Maniglia su rosetta e bocchetta  
ottone bombata 50 mm  
*Door handle on rounded brass rose  
and escutcheon 50 mm*

**211**  
Maniglia su rosetta e bocchetta  
ottone 55 mm  
*Door handle on brass rose and  
escutcheon 55 mm*

**212**  
Cremonese con meccanismo  
*Window handle with mechanism*

**213**  
Martellina q.7 senza meccanismo  
*Window handle 7 mm square  
without mechanism*

**214**  
Martellina DK  
*DK window handle*

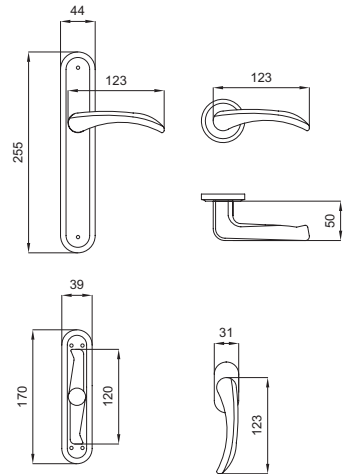

FINITURE / FINISHES  
OLV - ONS - ORO - ORA - PVD



# ONDA

**martinelli**  
HANDLES WITH CARE



**211/B PVD**

Maniglia su rosetta e bocchetta ottone bombata 50 mm  
*Door handle on rounded brass rose and escutcheon 50 mm*







DESIGN:  
EMILIO CUPOLO

# ONDA

# ORIZZONTE

ottone stampato a caldo - hot stamped brass



 <p><b>221</b></p>	 <p><b>224</b></p>	<p>FINITURE / FINISHES</p>  <p><b>221 - OLS</b></p>  <p><b>221 - CCS</b></p>  <p><b>221 - CNS</b></p>
 <p><b>220</b></p>		

**220**  
 Maniglia su placca  
*Door handle on plate*

**221**  
 Maniglia su rosetta e bocchetta  
 ottone 50 mm  
*Door handle on brass rose  
 and escutcheon 50 mm*

**224**  
 Martellina DK  
*DK window handle*

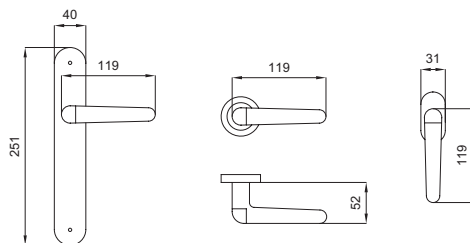

FINITURE / FINISHES  
 OLS - CCS - CNS



**221 CCS**

Maniglia su rosetta e bocchetta ottone 50 mm  
*Door handle on brass rose and escutcheon 50 mm*

DESIGN:  
EMILIO CUPOLO

 <p><b>568</b></p>	 <p><b>565</b></p>	<p>FINITURE / FINISHES</p>  <p><b>568/B - OLV</b></p>  <p><b>568/B - OGC</b></p>  <p><b>568/B - OGH</b></p>  <p><b>568/B - BSS</b></p>  <p><b>568/B - AF</b></p>  <p><b>568 - FAN</b></p>  <p><b>568/B - PVD</b> </p>
 <p><b>567</b></p>		

**567**  
 Maniglia su placca  
 Door handle on plate

**568/B**  
 Maniglia su rosetta e bocchetta  
 ottone bombata 50 mm  
 Door handle on rounded brass rose  
 and escutcheon 50 mm

**568**  
 Maniglia su rosetta e bocchetta  
 ottone 55 mm  
 Door handle on brass rose  
 and escutcheon 55 mm

**565**  
 martellina DK  
 DK window handle

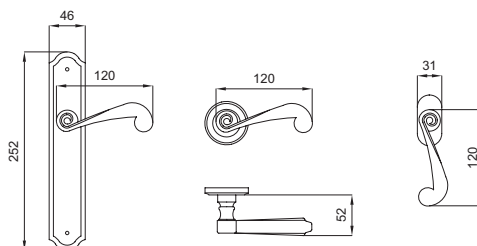

FINITURE / FINISHES  
**OLV - OGC - AF - OBV - OGH**  
**BSS - FAN - SIL - PVD**

# LADY

**martinelli**  
HANDLES WITH CARE



**568/B BSS**

Maniglia su rosetta e bocchetta ottone bombata 50 mm

*Door handle on rounded brass rose and escutcheon 50 mm*

# LADY

# CLASSIC

Materiale: ottone - solid brass

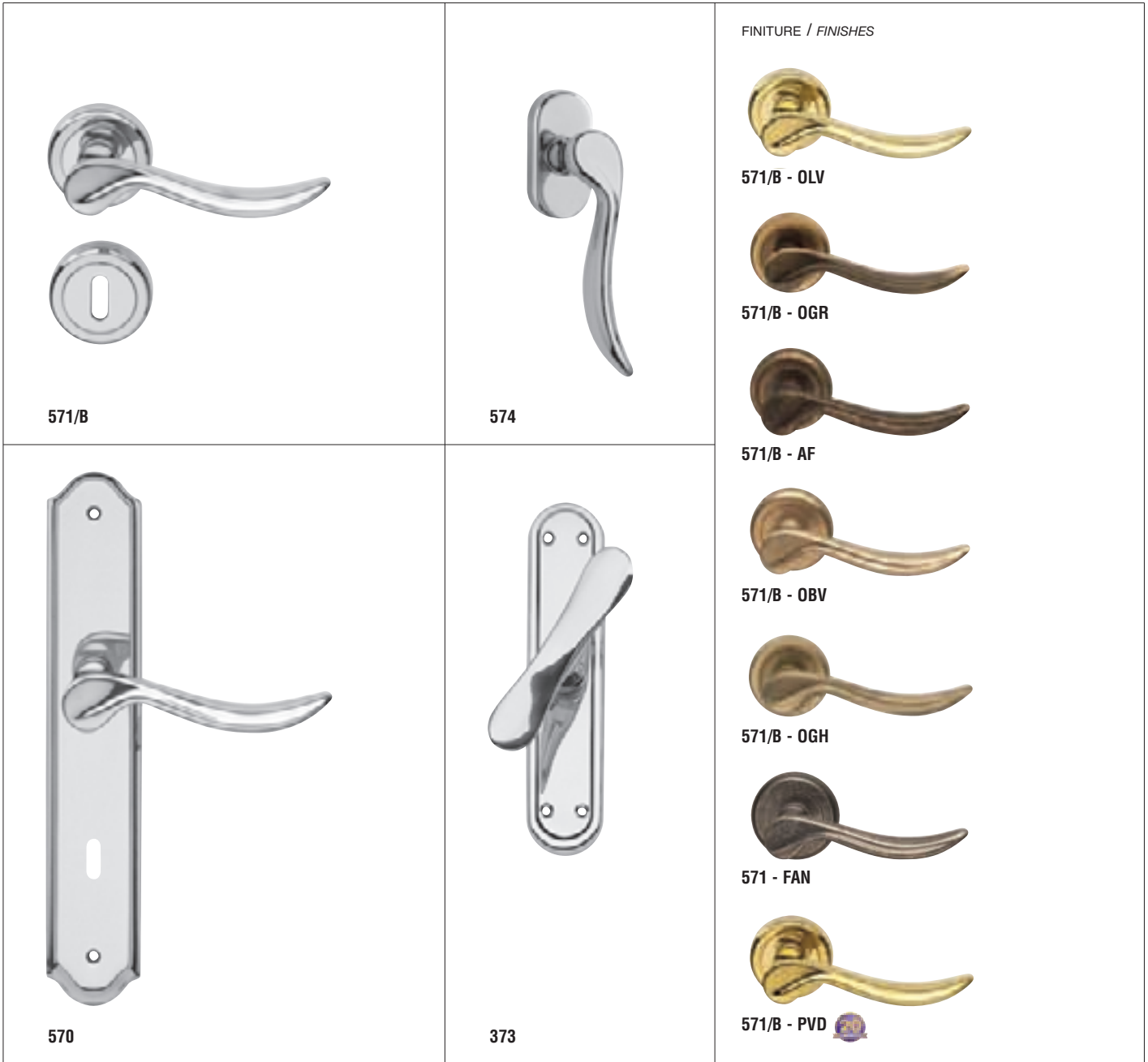

FINITURE / FINISHES



571/B - OLV



571/B - OGR



571/B - AF



571/B - OBV



571/B - OGH



571 - FAN



571/B - PVD

571/B

574

570

373

**570**  
Maniglia su placca Classic  
*Door handle on Classic plate*

**572**  
Maniglia su placca Cometa  
*Door handle on Cometa plate*

**571/B**  
Maniglia su rosetta e bocchetta  
ottone bombata 50 mm  
*Door handle on rounded brass  
rose and escutcheon 50 mm*

**571**  
Maniglia su rosetta e bocchetta  
ottone 55 mm  
*Door handle on brass rose  
and escutcheon 55 mm*

**372**  
Cremonese con meccanismo  
*Window handle with mechanism*

**373**  
Martellina q.7 senza meccanismo  
*Window handle 7 mm square  
without mechanism*

**574**  
Martellina DK  
*DK window handle*

**355**  
Martellina su rosetta ovale R011  
*window handle on R011  
oval rose*

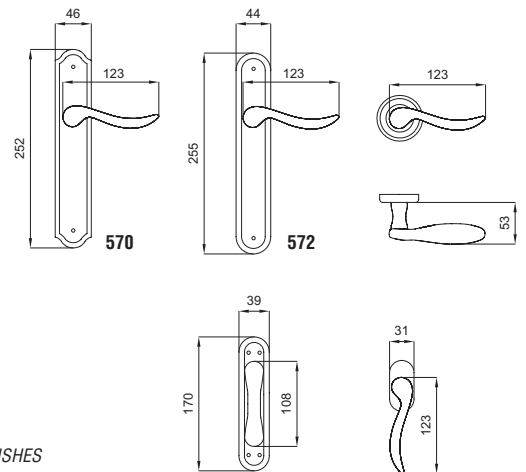

FINITURE / FINISHES  
OLV - OGR - AF - OBV - OGH  
FAN - SIL - ORO - ORA - PVD

# CLASSIC

**martinelli**  
HANDLES WITH CARE

DESIGN:  
MARTINELLI LAB



**571/B OLV**

Maniglia su rosetta e bocchetta ottone bombata 50 mm

*Door handle on rounded brass rose and escutcheon 50 mm*

# CLASSIC

# CLASSIC DUE

Materiale: ottone - solid brass



**577**  
Maniglia su placca Classic  
*Door handle on Classic plate*

**575**  
Maniglia su placca Cometa  
*Door handle on Cometa plate*

**576/B**  
Maniglia su rosetta e bocchetta  
ottone bombata 50 mm  
*Door handle on rounded brass  
rose and escutcheon 50 mm*

**576**  
Maniglia su rosetta e bocchetta  
ottone 55 mm  
*Door handle on brass rose  
and escutcheon 55 mm*

**372**  
Cremonese con meccanismo  
*Window handle with mechanism*

**373**  
Martellina q.7 senza meccanismo  
*Window handle 7 mm square  
without mechanism*

**573**  
Martellina DK  
*DK window handle*

**355**  
Martellina su rosetta ovale R011  
*Window handle on R011  
oval rose*

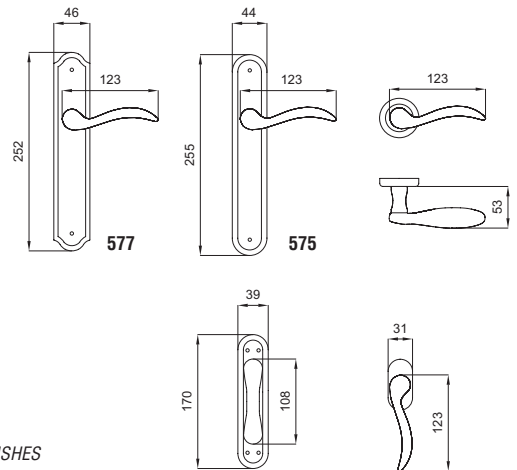

FINITURE / FINISHES  
OLV - OGR - AF - OBV - OGH  
FAN - SIL - ORO - ORA - PVD



# CLASSIC DUE

**martinelli**  
HANDLES WITH CARE



**576/B OGH**

Maniglia su rosetta e bocchetta ottone bombata 50 mm  
*Door handle on rounded brass rose and escutcheon 50 mm*

DESIGN:  
MARTINELLI LAB

CLASSIC DUE

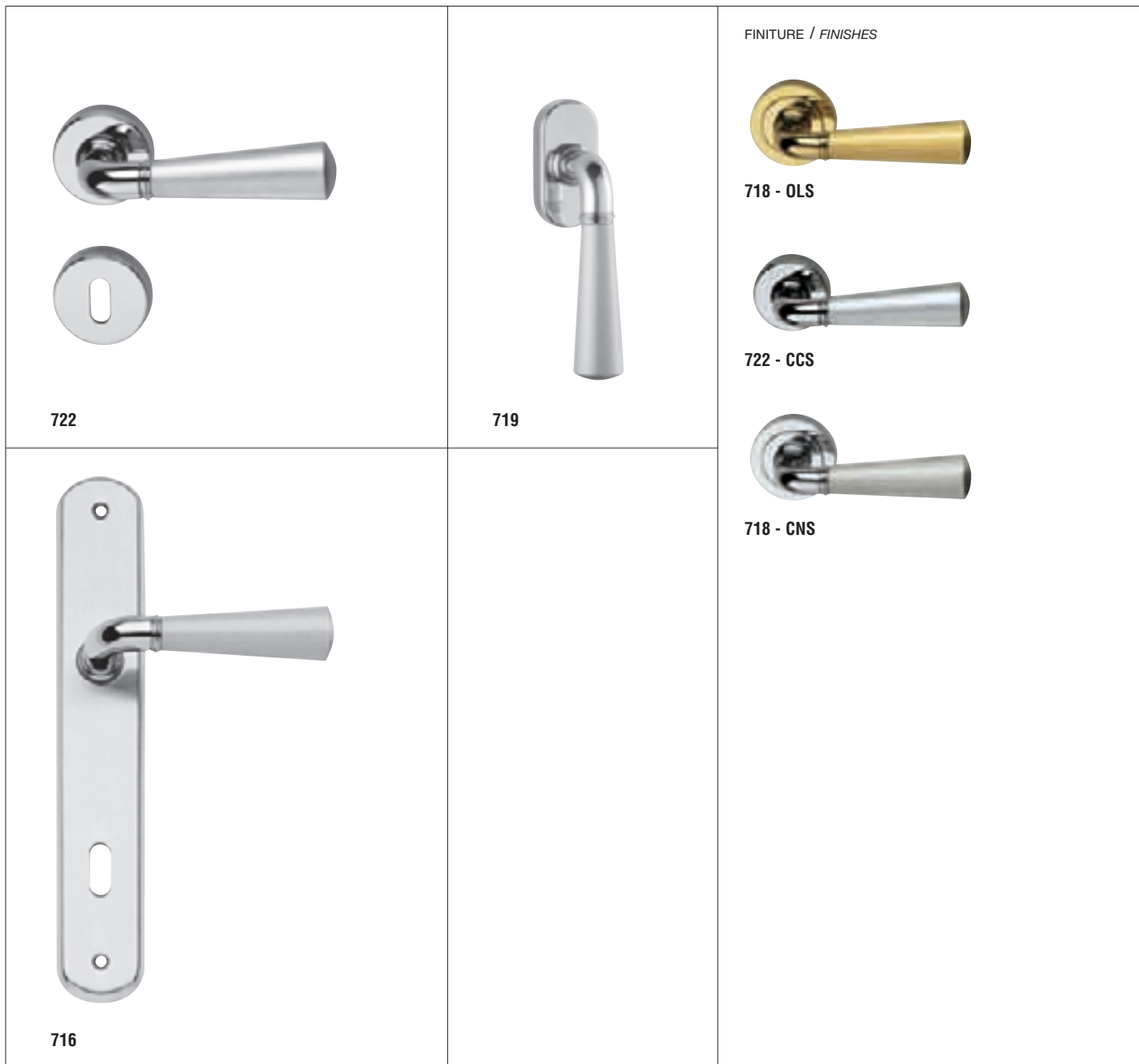

FINITURE / FINISHES



718 - OLS



722 - CCS



718 - CNS

722

719

716

**716**  
Maniglia su placca  
*Door handle on plate*

**718**  
Maniglia su rosetta e bocchetta  
ottone 50 mm  
*Door handle on brass rose  
and escutcheon 50 mm*

**722**  
Maniglia su rosetta e bocchetta  
nylon 45 mm  
*Door handle on nylon rose  
and escutcheon 45 mm*

**719**  
Martellina DK  
*DK window handle*

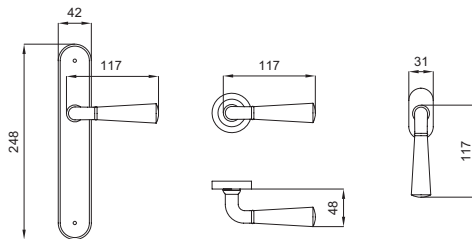

FINITURE / FINISHES  
OLS - CCS - CNS

# LISA

**martinelli**  
HANDLES WITH CARE

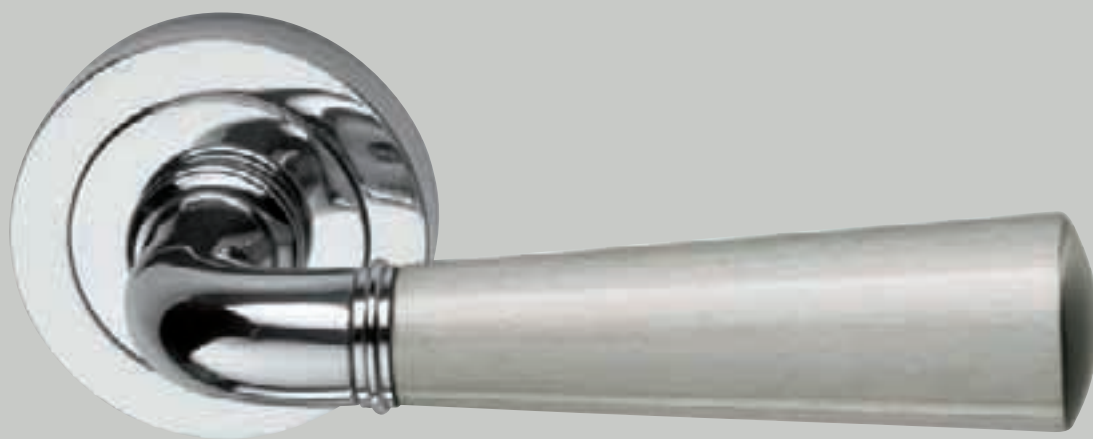

**718 CNS**

Maniglia su rosetta e bocchetta ottone 50 mm  
*Door handle on brass rose and escutcheon 50 mm*

DESIGN:  
MARTINELLI LAB

# LISA



**807**

Maniglia su placca Latina  
*Door handle on Latina plate*

**800**

Maniglia su placca Classic  
*Door handle on Classic plate*

**802**

Maniglia su placca Vienna  
*Door handle on Vienna plate*

**801/B**

Maniglia su rosetta e bocchetta  
ottone bombata 50 mm  
*Door handle on rounded brass rose  
and escutcheon 50 mm*

**801/L**

Maniglia su rosetta e bocchetta Latina  
*Door handle on Latina rose  
and escutcheon*

**803**

Maniglia su rosetta  
e bocchetta ovale  
*Door handle on oval rose  
and escutcheon*

**382**

Cremonese con meccanismo  
*Window handle with mechanism*

**383**

Martellina q.7 senza meccanismo  
*Window handle 7 mm square  
without mechanism*

**805**

Martellina DK  
*DK window handle*

**385**

Martellina su rosetta ovale R011  
*Window handle on R011 oval  
rose*

FINITURE / FINISHES

OLV - OGC - AF - OBV  
OGH - BSS - FAN - SIL

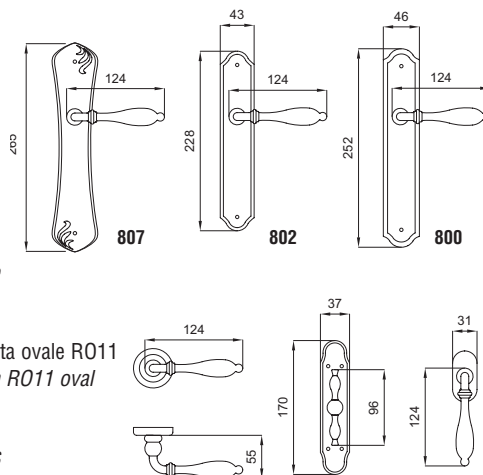

# LIRICA

**martinelli**  
HANDLES WITH CARE



**801/B OGH**

Maniglia su rosetta e bocchetta ottone bombata 50 mm  
*Door handle on rounded brass rose and escutcheon 50 mm*

DESIGN:  
MARTINELLI LAB

# LIRICA

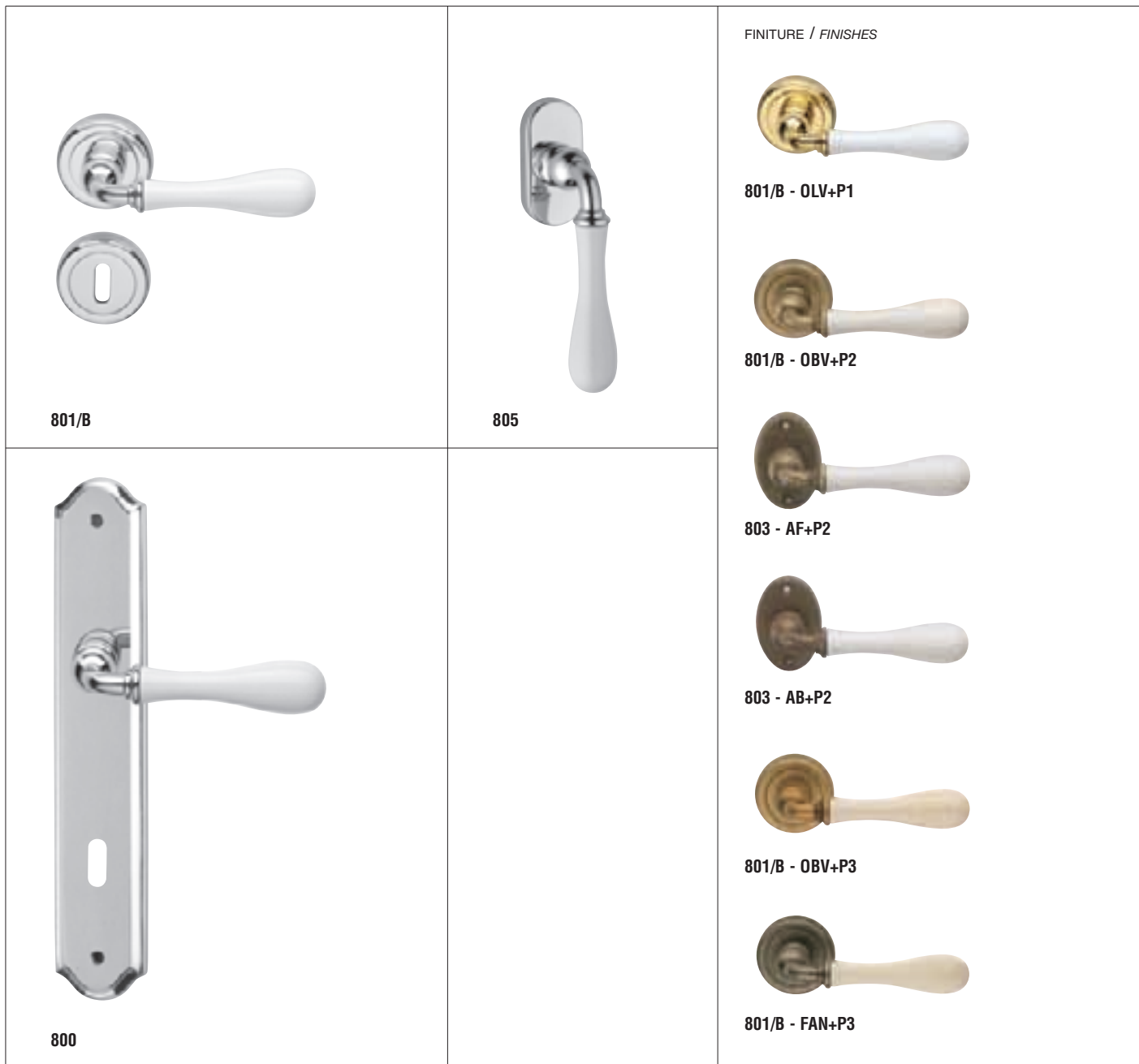

**801/B**

**805**

FINITURE / FINISHES

**801/B - OLV+P1**

**801/B - OBV+P2**

**803 - AF+P2**

**803 - AB+P2**

**801/B - OBV+P3**

**801/B - FAN+P3**

**800**

Maniglia su placca Classic  
*Door handle on Classic plate*

**805**

Martellina DK  
*DK window handle*

**802**

Maniglia su placca Vienna  
*Door handle on Vienna plate*

**801/B**

Maniglia su rosetta e bocchetta  
ottone bombata 50 mm  
*Door handle on rounded brass rose  
and escutcheon 50 mm*

**803**

Maniglia su rosetta e bocchetta ovale  
*Door handle on oval rose  
and escutcheon*

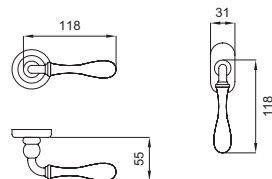
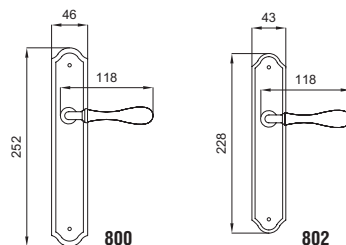

FINITURE / FINISHES

**OLV+P1 - OBV+P2 - AB+P2**

**AF+P2 - OBV+P3 - AB+P3**

**AF+P3 - OGH+P3 - FAN+P3**



**803 AF+P2**

Maniglia su rosetta e bocchetta ovale  
*Door handle on oval rose and escutcheon*

DESIGN:  
MARTINELLI LAB

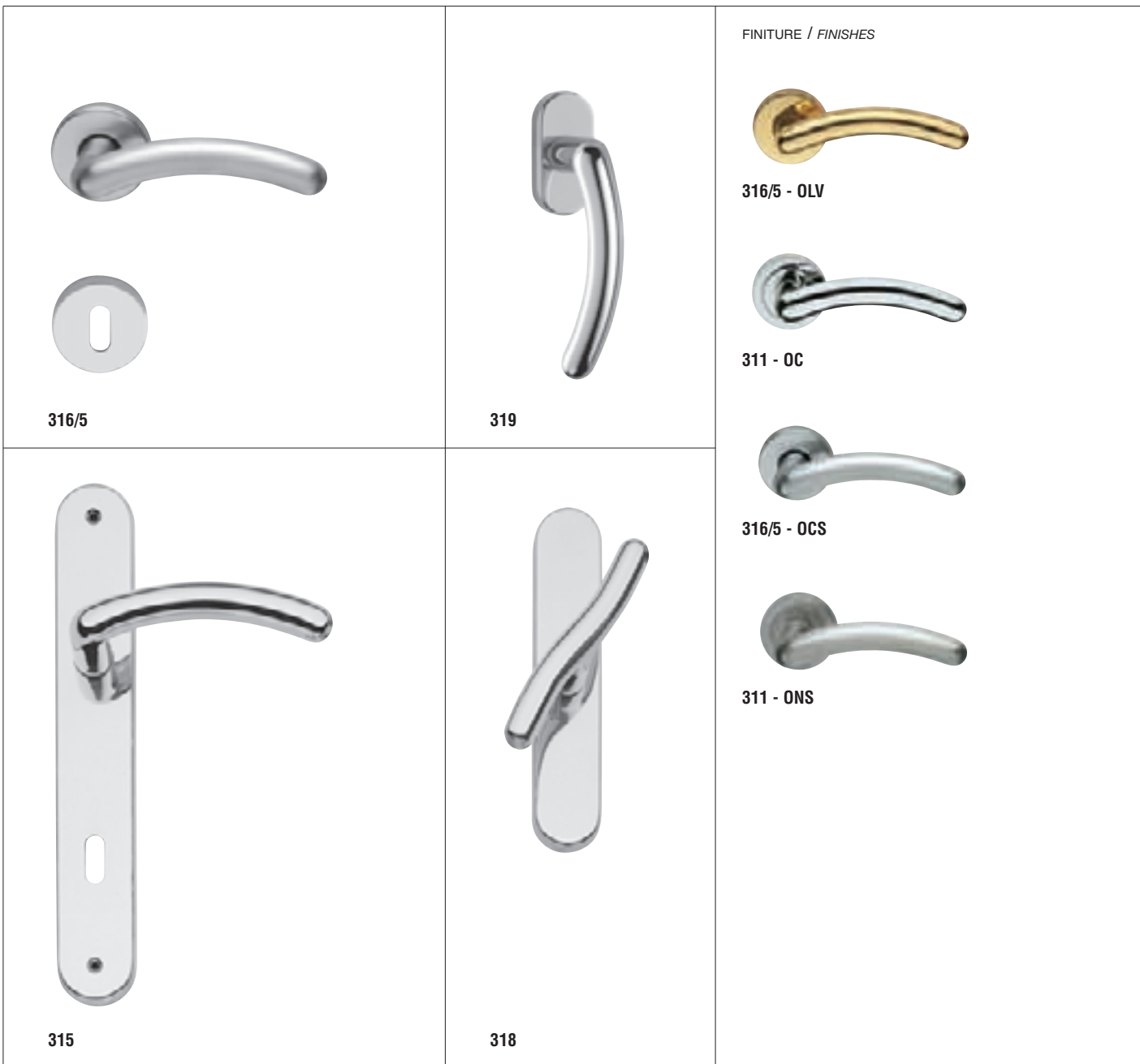

FINITURE / FINISHES



316/5 - OLV



311 - OC



316/5 - OCS



311 - ONS

**315**  
Maniglia su placca  
*Door handle on plate*

**311**  
Maniglia su rosetta e bocchetta  
ottone 50 mm  
*Door handle on brass rose  
and escutcheon 50 mm*

**316/5**  
Maniglia su rosetta e bocchetta  
nylon 50 mm  
*Door handle on nylon rose  
and escutcheon 50 mm*

**317**  
Cremonese con meccanismo  
*Window handle with mechanism*

**318**  
Martellina con meccanismo  
q. 7x45 mm  
*Window handle with mechanism  
and 7x45 mm spindle*

**319**  
Martellina DK  
*DK window handle*

**312**  
Martellina su rosetta ovale R011  
*Window handle on R011  
oval rose*

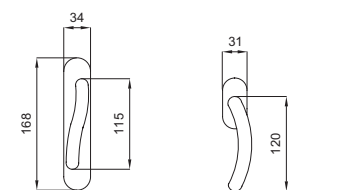
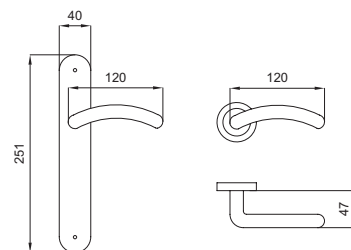

FINITURE / FINISHES  
OLV - OC - OCS - ONS



# NOXIA

**martinelli**  
HANDLES WITH CARE

DESIGN:  
MARTINELLI LAB



**311 ONS**

Maniglia su rosetta e bocchetta ottone 50 mm  
*Door handle on brass rose and escutcheon 50 mm*

# NOXIA

# NOXIA-B

Materiale: ottone - solid brass

 <p><b>307</b></p>	 <p><b>309</b></p>	<p>FINITURE / FINISHES</p>  <p><b>307 - OLS</b></p>  <p><b>308/5 - CCS</b></p>
 <p><b>306</b></p>		
<p><b>306</b> Maniglia su placca <i>Door handle on plate</i></p> <p><b>307</b> Maniglia su rosetta e bocchetta ottone 50 mm <i>Door handle on brass rose and escutcheon 50 mm</i></p> <p><b>308/5</b> Maniglia su rosetta e bocchetta nylon 50 mm <i>Door handle on nylon rose and escutcheon 50 mm</i></p> <p><b>309</b> Martellina DK <i>DK window handle</i></p>		 <p>FINITURE / FINISHES <b>OLS - CCS</b></p>

# NOXIA-B

**martinelli**  
HANDLES WITH CARE

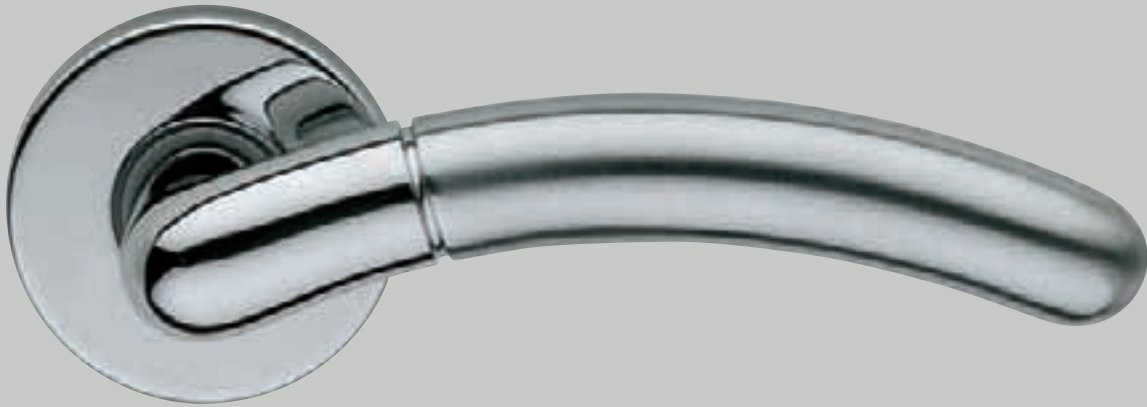

**308/5 CCS**

Maniglia su rosetta e bocchetta nylon 50 mm  
*Door handle on nylon rose and escutcheon 50 mm*

DESIGN:  
MARTINELLI LAB

# NOXIA-B



321

324

FINITURE / FINISHES



321 - OLS



327 - CCS



327 CNS

320

323

**320**  
Maniglia su placca  
*Door handle on plate*

**327**  
Maniglia su rosetta e bocchetta  
ottone 50 mm  
*Door handle on brass rose  
and escutcheon 50 mm*

**321**  
Maniglia su rosetta e bocchetta  
nylon 45 mm  
*Door handle on nylon rose  
and escutcheon 45 mm*

**321/5**  
Maniglia su rosetta e bocchetta  
nylon 50 mm  
*Door handle on nylon rose  
and escutcheon 50 mm*

**322**  
Cremonese con meccanismo  
*Window handle with mechanism*

**323**  
Martellina con meccanismo  
q. 7x45 mm  
*Window handle with mechanism  
and 7x45 mm spindle*

**324**  
Martellina DK  
*DK window handle*

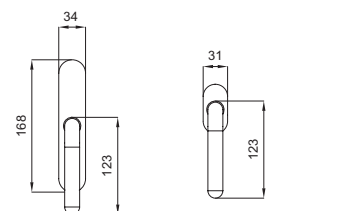
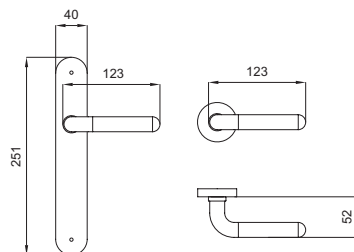

FINITURE / FINISHES  
OLS - CCS - CNS

# POLO

**martinelli**  
HANDLES WITH CARE



**327 CCS**

Maniglia su rosetta e bocchetta ottone 50 mm

*Door handle on brass rose and escutcheon 50 mm*

---

# POLO



**326**  
Maniglia su placca  
*Door handle on plate*

**328**  
Maniglia su rosetta e bocchetta  
ottone 50 mm  
*Door handle on brass rose  
and escutcheon 50 mm*

**329**  
Maniglia su rosetta e bocchetta  
nylon 45 mm  
*Door handle on nylon rose  
and escutcheon 45 mm*

**329/5**  
Maniglia su rosetta e bocchetta  
nylon 50 mm  
*Door handle on nylon rose  
and escutcheon 50 mm*

**322B**  
Cremonese con meccanismo  
*Window handle with mechanism*

**323B**  
Martellina con meccanismo  
q. 7x45 mm  
*Window handle with mechanism  
and 7x45 mm spindle*

**325**  
Martellina DK  
*DK window handle*

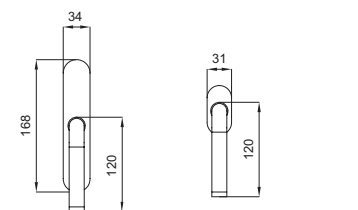
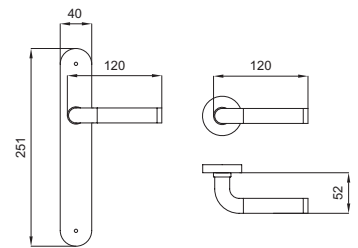

FINITURE / FINISHES  
**OLS - CCS - CNS**

# POLO-B

**martinelli**  
HANDLES WITH CARE



**329 OLS**

Maniglia su rosetta e bocchetta nylon 45 mm  
*Door handle on nylon rose and escutcheon 45 mm*

POLO-B



FINITURE / FINISHES



251/5 - OLV



251/5 - OGC



251/5 - AB



251/5 - AF



251/5 - PVD

**250**  
Maniglia su placca Lorena  
*Door handle on Lorena plate*

**250/NX**  
Maniglia su placca Noxia  
*Door handle on Noxia plate*

**251/OT**  
Maniglia su rosetta e bocchetta  
ottone 50 mm  
*Door handle on brass rose  
and escutcheon 50 mm*

**251**  
Maniglia su rosetta e bocchetta  
nylon 45 mm  
*Door handle on nylon rose  
and escutcheon 45 mm*

**251/5**  
Maniglia su rosetta e bocchetta  
nylon 50 mm  
*Door handle on nylon rose  
and escutcheon 50 mm*

**252**  
Cremonese con meccanismo  
*Window handle with mechanism*

**253**  
Martellina q.7 senza meccanismo  
*Window handle 7 mm square  
without mechanism*

**254**  
Martellina DK  
*DK window handle*

**259**  
Martellina su rosetta ovale  
R011  
*window handle on R011  
oval rose*

FINITURE / FINISHES  
OLV - OGC - AB - AF - PVD

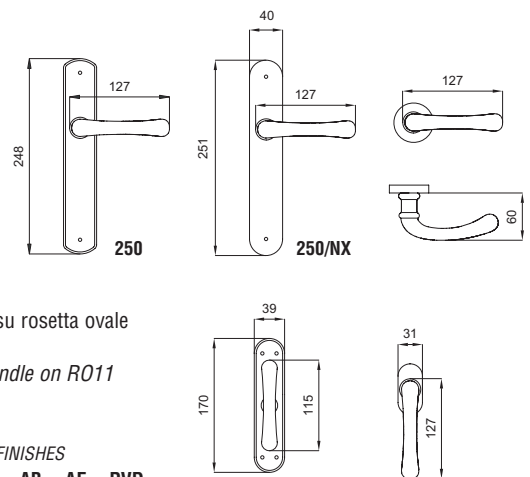



# LORENA

**martinelli**  
HANDLES WITH CARE



**251/5 OLV**

Maniglia su rosetta e bocchetta nylon 50 mm

*Door handle on nylon rose and escutcheon 50 mm*

# LORENA



FINITURE / FINISHES



737 - OLV



736/5 - OS



737 - OC



736 - OCS

**734**  
Maniglia su placca Sabina  
*Door handle on Sabina plate*

**735**  
Maniglia su placca Noxia  
*Door handle on Noxia plate*

**737**  
Maniglia su rosetta e bocchetta  
ottone 50 mm  
*Door handle on brass rose  
and escutcheon 50 mm*

**736**  
Maniglia su rosetta e bocchetta  
nylon 45 mm  
*Door handle on nylon rose  
and escutcheon 45 mm*

**736/5**  
Maniglia su rosetta e bocchetta  
nylon 50 mm  
*Door handle on nylon rose  
and escutcheon 50 mm*

**738**  
Cremonese con meccanismo  
*Window handle with mechanism*  
**739**  
Martellina con meccanismo  
q. 7x45 mm  
*Window handle with mechanism  
and 7x45 mm spindle*

**740NY**  
Martellina DK con meccanismo nylon  
*DK window handle with nylon  
mechanism*

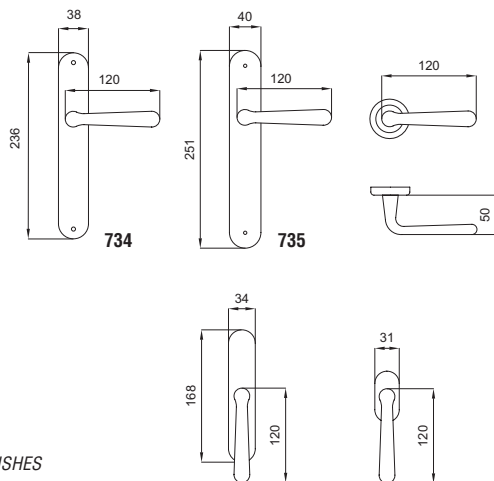

FINITURE / FINISHES  
OLV - OS - OC - OCS

# CAROLA

**martinelli**  
HANDLES WITH CARE

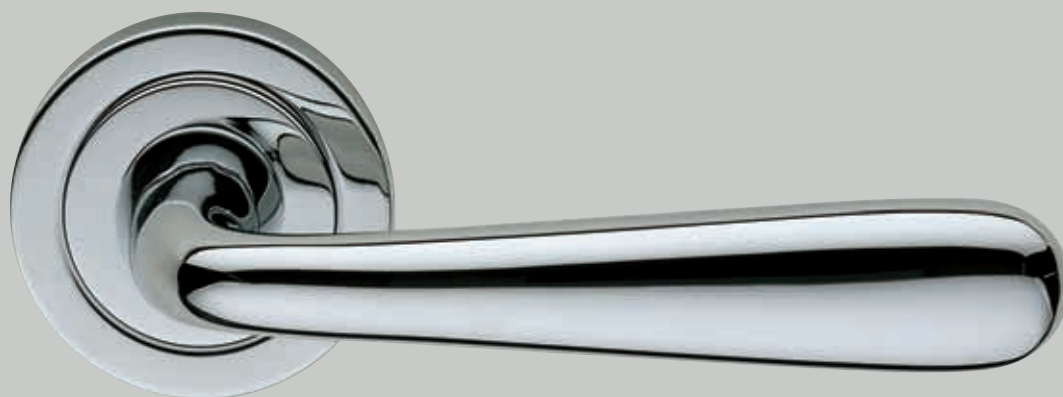

**737 OC**

Maniglia su rosetta e bocchetta ottone 50 mm  
*Door handle on brass rose and escutcheon 50 mm*

CAROLA



FINITURE / FINISHES

241 - OLV

241 - OC

241/OT - OCS

241

244

240

243

**240**  
Maniglia su placca  
*Door handle on plate*

**241/OT**  
Maniglia su rosetta e bocchetta  
ottone 50 mm  
*Door handle on brass rose  
and escutcheon 50 mm*

**241**  
Maniglia su rosetta e bocchetta  
nylon 45 mm  
*Door handle on nylon rose  
and escutcheon 45 mm*

**241/5**  
Maniglia su rosetta e bocchetta  
nylon 50 mm  
*Door handle on nylon rose  
and escutcheon 50 mm*

**242**  
Cremonese con meccanismo  
*Window handle with mechanism*

**243**  
Martellina q.7 senza meccanismo  
*Window handle 7 mm square  
without mechanism*

**244**  
Martellina DK  
*DK window handle*

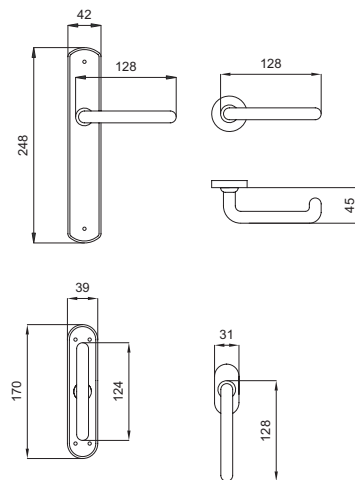

FINITURE / FINISHES  
OLV - OC - OCS

# DIANA

**martinelli**  
HANDLES WITH CARE

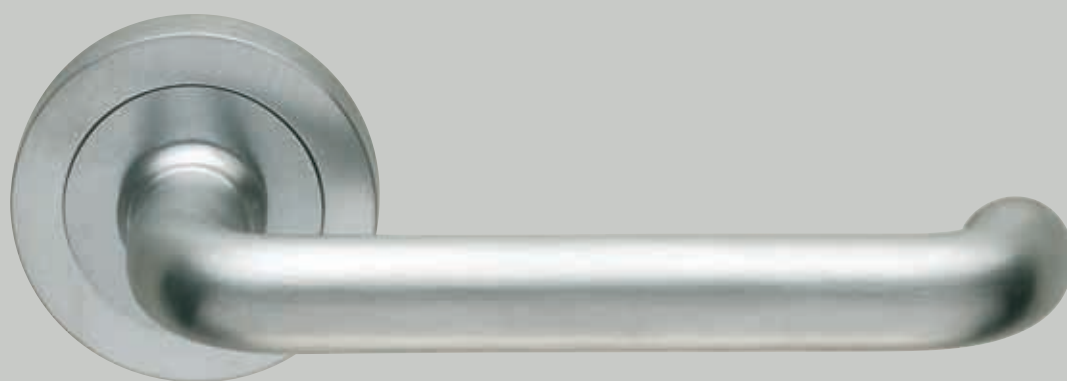

**241/OT OCS**

Maniglia su rosetta e bocchetta ottone 50 mm  
*Door handle on brass rose and escutcheon 50 mm*

# DIANA



FINITURE / FINISHES



246 - OLV



246 - OC



246/5 - OCS

**245**

Maniglia su placca  
*Door handle on plate*

**246/OT**

Maniglia su rosetta e bocchetta  
ottone 50 mm  
*Door handle on brass rose  
and escutcheon 50 mm*

**246**

Maniglia su rosetta e bocchetta  
nylon 45 mm  
*Door handle on nylon rose  
and escutcheon 45 mm*

**246/5**

Maniglia su rosetta e bocchetta  
nylon 50 mm  
*Door handle on nylon rose  
and escutcheon 50 mm*

**247**

Cremonese con meccanismo  
*Window handle with mechanism*

**248**

Martellina q.7 senza meccanismo  
*Window handle 7 mm square  
without mechanism*

**249**

Martellina DK  
*DK window handle*

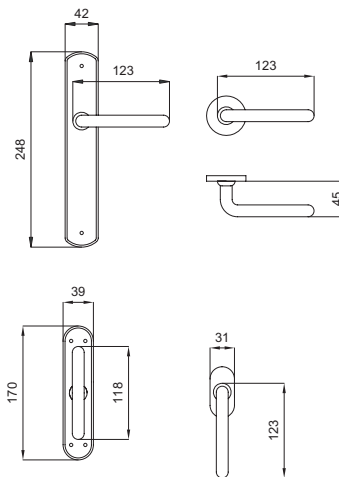

FINITURE / FINISHES  
OLV - OC - OCS

# ELENA

**martinelli**  
HANDLES WITH CARE



ELENA

**246 OLV**

Maniglia su rosetta e bocchetta nylon 45 mm

*Door handle on nylon rose and escutcheon 45 mm*

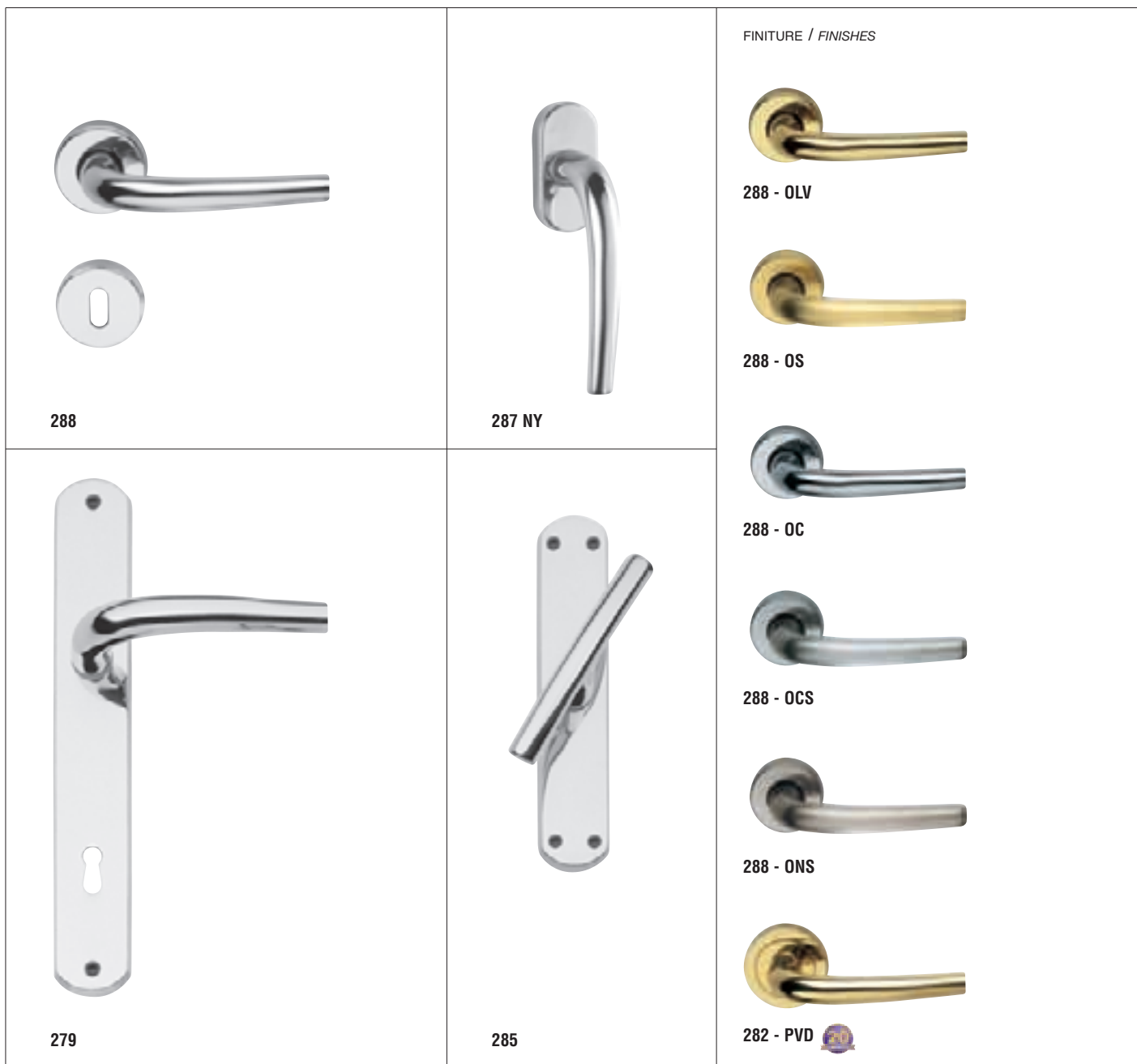

**279**  
Maniglia su placca  
*Door handle on plate*

**282**  
Maniglia su rosetta e bocchetta  
ottone 50 mm  
*Door handle on brass rose  
and escutcheon 50 mm*

**288**  
Maniglia su rosetta e bocchetta  
nylon 45 mm  
*Door handle on nylon rose  
and escutcheon 45 mm*

**288/5**  
Maniglia su rosetta e bocchetta  
nylon 50 mm  
*Door handle on nylon rose  
and escutcheon 50 mm*

**283**  
Cremonese con meccanismo  
*Window handle with mechanism*

**285**  
Martellina q.7 senza meccanismo  
*Window handle 7 mm square  
without mechanism*

**287/NY**  
Martellina DK  
*DK window handle*

**286**  
Martellina su rosetta ovale RO11  
*Window handle on RO11  
oval rose*

**MM288**  
Mezza maniglia Sabina  
su rosetta nylon, mm 45  
senza bocchetta con ferro  
ad espansione q. 8x65  
*Half door handle on nylon rose  
45 mm, w/out escutcheon-with  
8x65 expansion square spindle*

FINITURE / FINISHES  
**OLV - OS - OC - OCS - ONS**  
**PVD - PVD INOX**

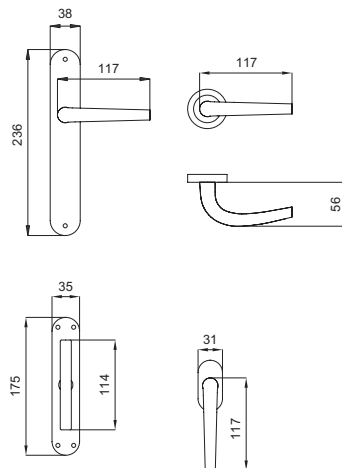



# SABINA

**martinelli**  
HANDLES WITH CARE



**288 OLV**

Maniglia su rosetta e bocchetta nylon 45 mm

*Door handle on nylon rose and escutcheon 45 mm*

# SABINA



**700**  
Maniglia su placca Sabina  
*Door handle on Sabina plate*

**701**  
Maniglia su placca Noxia  
*Door handle on Noxia plate*

**706**  
Maniglia su rosetta e bocchetta  
ottone 50 mm  
*Door handle on brass rose  
and escutcheon 50 mm*

**702**  
Maniglia su rosetta e bocchetta  
nylon 45 mm  
*Door handle on nylon rose  
and escutcheon 45 mm*

**702/5**  
Maniglia su rosetta e bocchetta  
nylon 50 mm  
*Door handle on nylon rose  
and escutcheon 50 mm*

**703**  
Cremonese con meccanismo  
*Window handle with mechanism*

**704**  
Martellina q.7 senza meccanismo  
*Window handle 7 mm square  
without mechanism*

**705**  
Martellina DK  
*DK window handle*

**707**  
Martellina su rosetta ovale RO11  
*window handle on RO11  
oval rose*

FINITURE / FINISHES  
**OLV - OS - OGC**  
**OC - OCS - ONS**

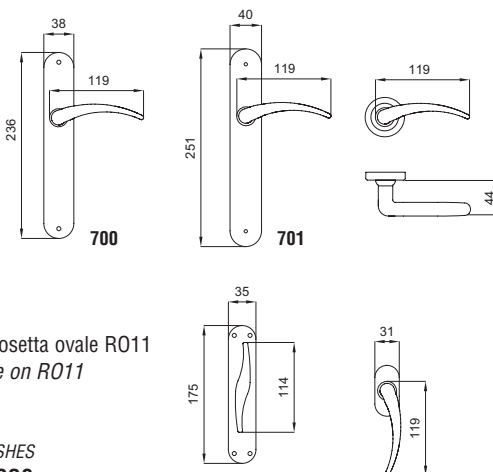

# WING

**martinelli**  
HANDLES WITH CARE

DESIGN:  
MARTINELLI LAB



**706 OCS**

Maniglia su rosetta e bocchetta ottone 50 mm  
*Door handle on brass rose and escutcheon 50 mm*

# WING

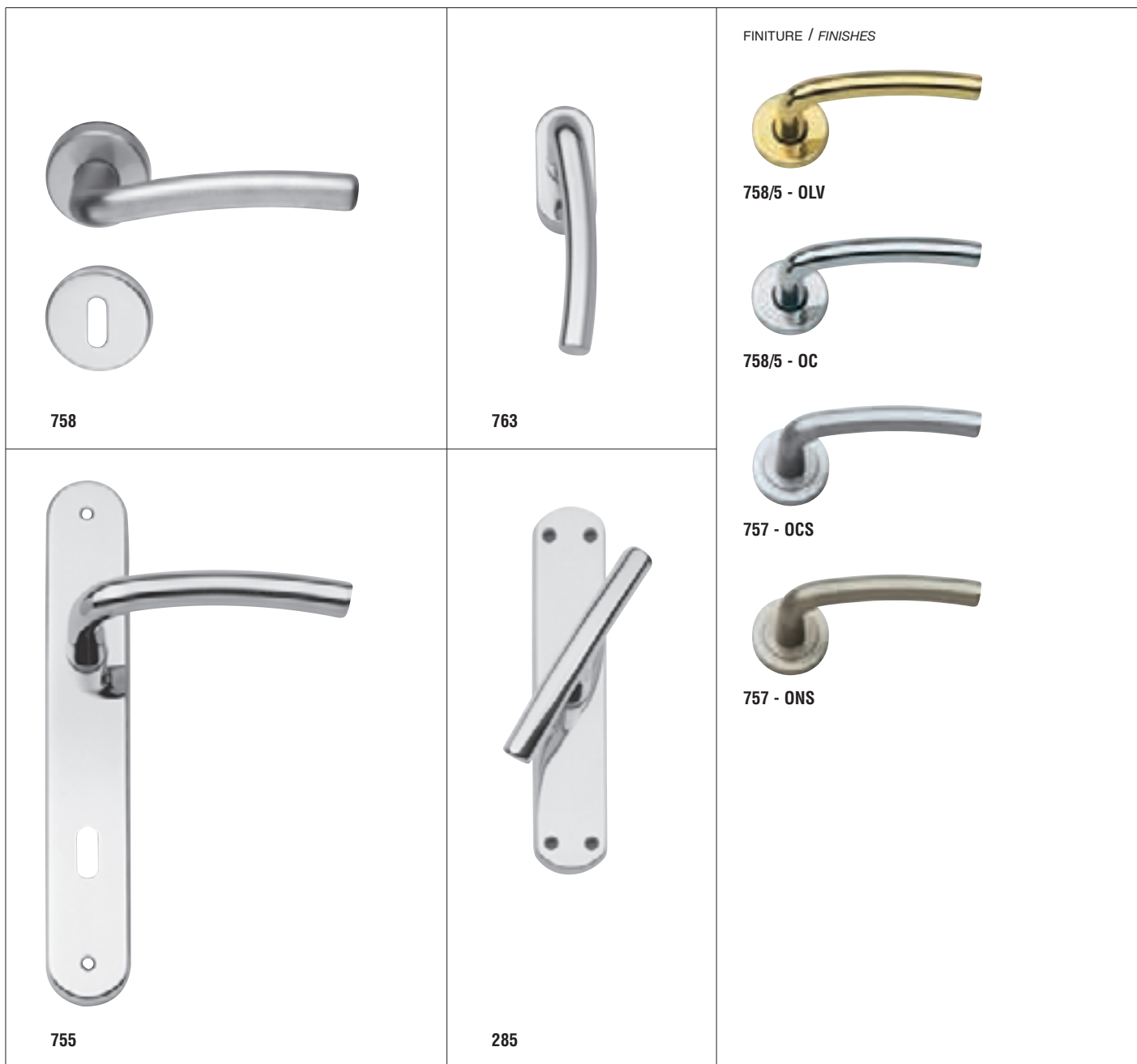

**755**  
Maniglia su placca  
*Door handle on plate*

**757**  
Maniglia su rosetta e bocchetta  
ottone 50 mm  
*Door handle on brass rose  
and escutcheon 50 mm*

**758**  
Maniglia su rosetta e bocchetta  
nylon 45 mm  
*Door handle on nylon rose  
and escutcheon 45 mm*

**758/5**  
Maniglia su rosetta e bocchetta  
nylon 50 mm  
*Door handle on nylon rose  
and escutcheon 50 mm*

**283**  
Cremonese con meccanismo  
*Window handle with mechanism*

**285**  
Martellina q.7 senza meccanismo  
*Window handle 7 mm square  
without mechanism*

**763**  
Martellina DK  
*DK window handle*

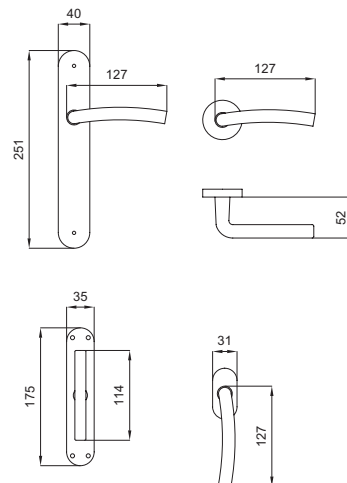

FINITURE / FINISHES  
**OLV - OC - OCS - ONS**

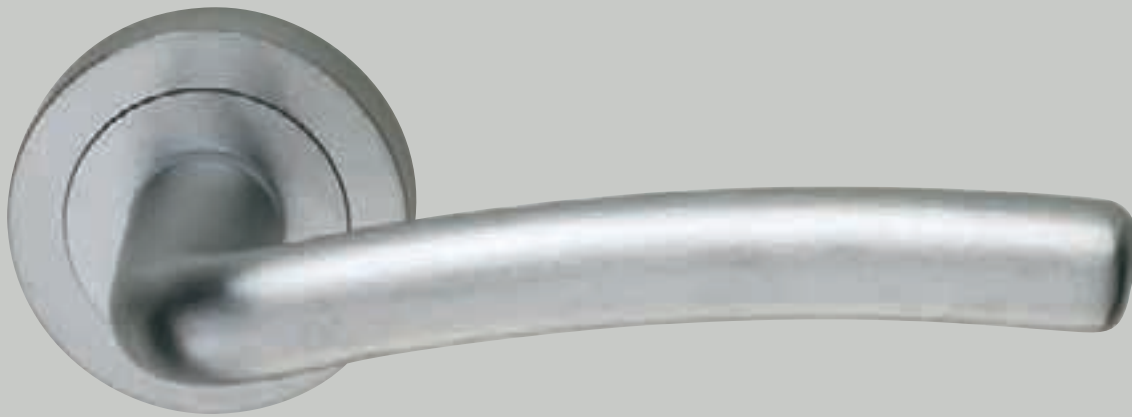

**757 OCS**

Maniglia su rosetta e bocchetta ottone 50 mm  
*Door handle on brass rose and escutcheon 50 mm*



FINITURE / FINISHES



767/5 - OLV



766 - OC

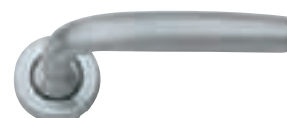

767/5 - OCS

767/5

770

764

769

**764**  
Maniglia su placca  
*Door handle on plate*

**766**  
Maniglia su rosetta e bocchetta  
ottone 50 mm  
*Door handle on brass rose  
and escutcheon 50 mm*

**767/5**  
Maniglia su rosetta e bocchetta  
nylon 50 mm  
*Door handle on nylon rose  
and escutcheon 50 mm*

**768**  
Cremonese con meccanismo  
*Window handle with mechanism*

**769**  
Martellina con meccanismo  
q. 7x45 mm  
*Window handle with mechanism  
and 7x45 mm spindle*

**770**  
Martellina DK  
*DK window handle*

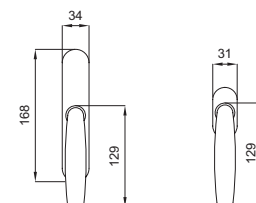
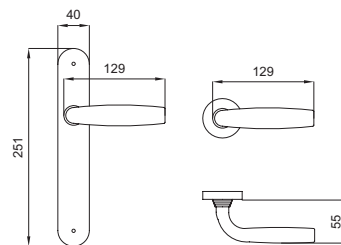

FINITURE / FINISHES  
OLV - OC - OCS

Fino ad esaurimento scorte  
*As off selling out*



**766 OC**

Maniglia su rosetta e bocchetta ottone 50 mm  
*Door handle on brass rose and escutcheon 50 mm*

# OVALE

Materiale: ottone - solid brass

 <p><b>291</b></p>	 <p><b>294</b></p>	<p>FINITURE / FINISHES</p>  <p><b>291 - OLV</b></p>  <p><b>291 - OGR</b></p>  <p><b>291 - OC</b></p>  <p><b>291 - OCS</b></p>
	 <p><b>297</b></p>	

**291**  
 Maniglia su rosetta e bocchetta  
 ottone 50 mm  
*Door handle on brass rose  
 and escutcheon 50 mm*

**294**  
 Maniglia su rosetta e bocchetta ovale  
*Door handle on oval rose  
 and escutcheon*

**296**  
 Cremonese con meccanismo  
*Window handle with mechanism*

**297**  
 Martellina q.7 senza meccanismo  
*Window handle 7 mm square  
 without mechanism*

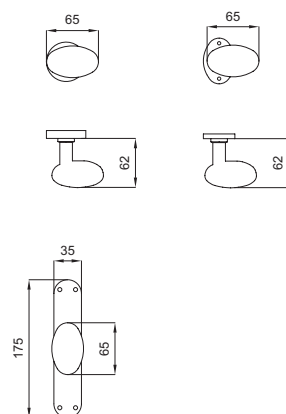

FINITURE / FINISHES  
**OLV - OGR - OC - OCS**



# OVALE

**martinelli**  
HANDLES WITH CARE



**291 OCS**

Maniglia su rosetta e bocchetta ottone 50 mm  
*Door handle on brass rose and escutcheon 50 mm*

# OVALE

# OVALE CENTRALE

Materiale: ottone - solid brass

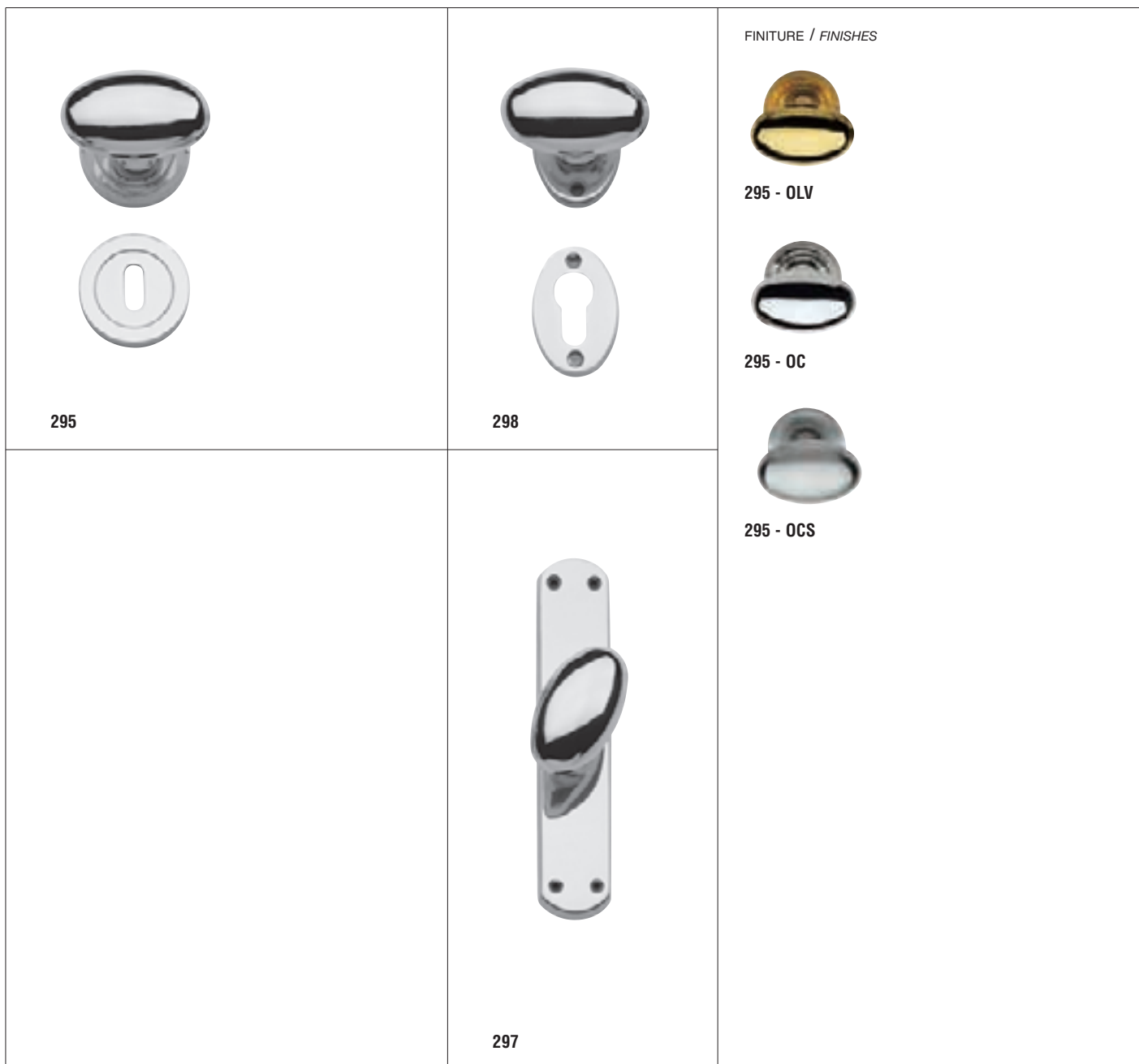

FINITURE / FINISHES



295 - OLV



295 - OC



295 - OCS

**295**

Maniglia su rosetta e bocchetta  
ottone 50 mm  
*Door handle on brass rose  
and escutcheon 50 mm*

**298**

Maniglia su rosetta e bocchetta ovale  
*Door handle on oval rose  
and escutcheon*

**299/5**

Maniglia su rosetta e bocchetta  
nylon 50 mm  
*Door handle on nylon rose  
and escutcheon 50 mm*

**296**

Cremonese con meccanismo  
*Window handle with mechanism*

**297**

Martellina q.7 senza meccanismo  
*Window handle 7 mm square  
without mechanism*

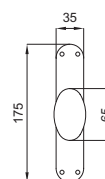

FINITURE / FINISHES  
OLV - AF - OC - OCS

# OVALE CENTRALE



**295 OCS**

Maniglia su rosetta e bocchetta ottone 50 mm  
*Door handle on brass rose and escutcheon 50 mm*

OVALE CENTRALE

 <p><b>304</b></p>	 <p><b>300</b></p>	<p>FINITURE / FINISHES</p>  <p><b>304 - OLV</b></p>  <p><b>300 - OS</b></p>  <p><b>300 - OC</b></p>  <p><b>300 - OCS</b></p>
 <p><b>303</b></p>		

**303**  
 Maniglia su placca  
 Door handle on plate

**304**  
 Maniglia su rosetta e bocchetta  
 ottone 50 mm  
 Door handle on brass rose  
 and escutcheon 50 mm

**300**  
 Maniglia su rosetta e bocchetta  
 nylon 45 mm  
 Door handle on nylon rose  
 and escutcheon 45 mm

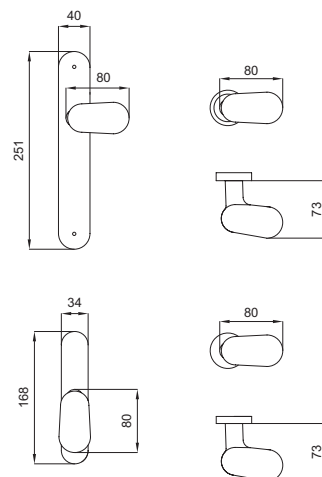

FINITURE / FINISHES  
**OLV - OS - OC - OCS**

# GOCCIA

**martinelli**  
HANDLES WITH CARE



**304 OLV**

Maniglia su rosetta e bocchetta ottone 50 mm  
*Door handle on brass rose and escutcheon 50 mm*

# GOCCIA



FINITURE / FINISHES



391 - OLV



391 - AF



399 - OBV



391 - OGC



399 - FAN



399 - SIL

391

396

390

395

**390**

Maniglia su placca  
*Door handle on plate*

**398**

Maniglia su placca Vienna  
*Door handle on Vienna plate*

**391**

Maniglia su rosetta e bocchetta  
nylon 45 mm  
*Door handle on nylon rose  
and escutcheon 45 mm*

**391/5**

Maniglia su rosetta e bocchetta  
nylon 50 mm  
*Door handle on nylon rose  
and escutcheon 50 mm*

**399**

Maniglia su rosetta e bocchetta ovale  
*Door handle on oval rose  
and escutcheon*

**394**

Cremonese con meccanismo  
*Window handle with mechanism*

**395**

Martellina q.7 senza meccanismo  
*Window handle 7 mm square  
without mechanism*

**396**

Martellina DK  
*DK window handle*

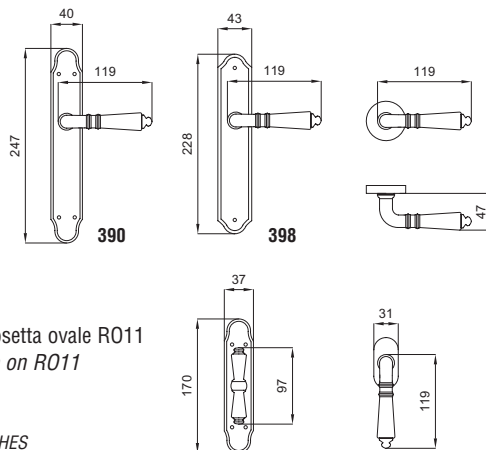

**397**

Martellina su rosetta ovale RO11  
*Window handle on RO11  
oval rose*

FINITURE / FINISHES

OLV - AF - OBV - OGC  
OGH - FAN - SIL

# DANIELA

**martinelli**  
HANDLES WITH CARE



**391 AF**

Maniglia su rosetta e bocchetta nylon 45 mm

*Door handle on nylon rose and escutcheon 45 mm*

# DANIELA

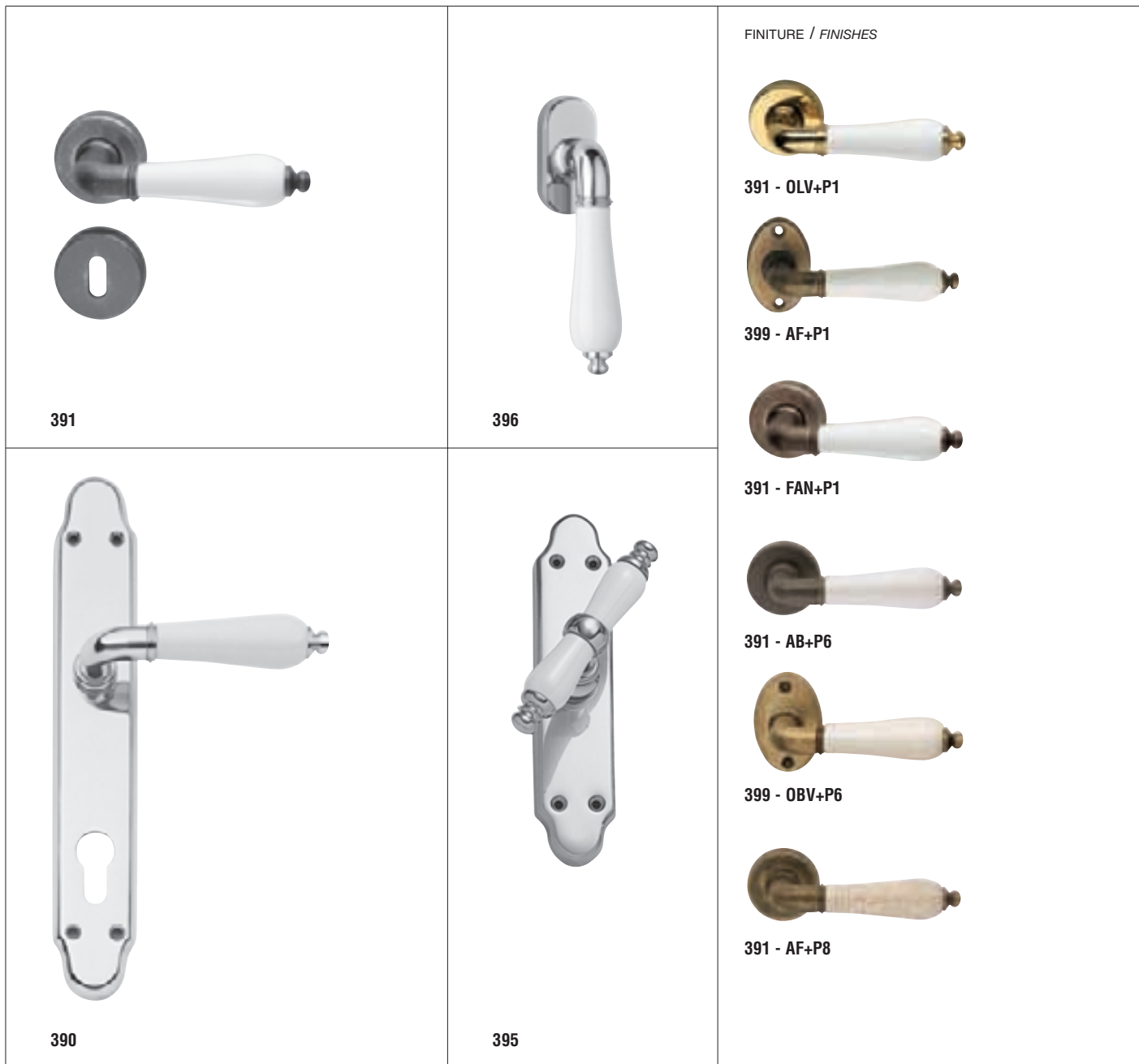

391

396

FINITURE / FINISHES



391 - OLV+P1



391 - AF+P1



391 - FAN+P1



391 - AB+P6



391 - OBV+P6



391 - AF+P8

390

395

**390**  
Maniglia su placca Daniela  
*Door handle on Daniela plate*

**398**  
Maniglia su placca Vienna  
*Door handle on Vienna plate*

**391**  
Maniglia su rosetta e bocchetta  
nylon 45 mm  
*Door handle on nylon rose  
and escutcheon 45 mm*

**391/5**  
Maniglia su rosetta e bocchetta  
nylon 50 mm  
*Door handle on nylon rose  
and escutcheon 50 mm*

**399**  
Maniglia su rosetta e bocchetta ovale  
*Door handle on oval rose  
and escutcheon*

**394**  
Cremonese con meccanismo  
*Window handle with mechanism*

**395**  
Martellina q.7 senza meccanismo  
*Window handle 7 mm square  
without mechanism*

**396**  
Martellina DK  
*DK window handle*

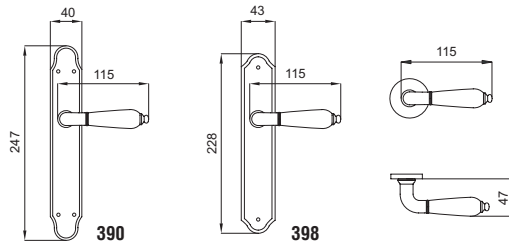

**397**  
Martellina su rosetta ovale RO11  
*window handle on RO11  
oval rose*

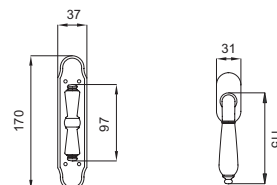

FINITURE / FINISHES  
**OLV+P1 - AF+P1 - FAN+P1**  
**AB+P6 - AF+P6 - OBV+P6**  
**AB+P8 - AF+P8**





**399 AF+P6**

Maniglia su rosetta e bocchetta ovale  
*Door handle on oval rose and escutcheon*

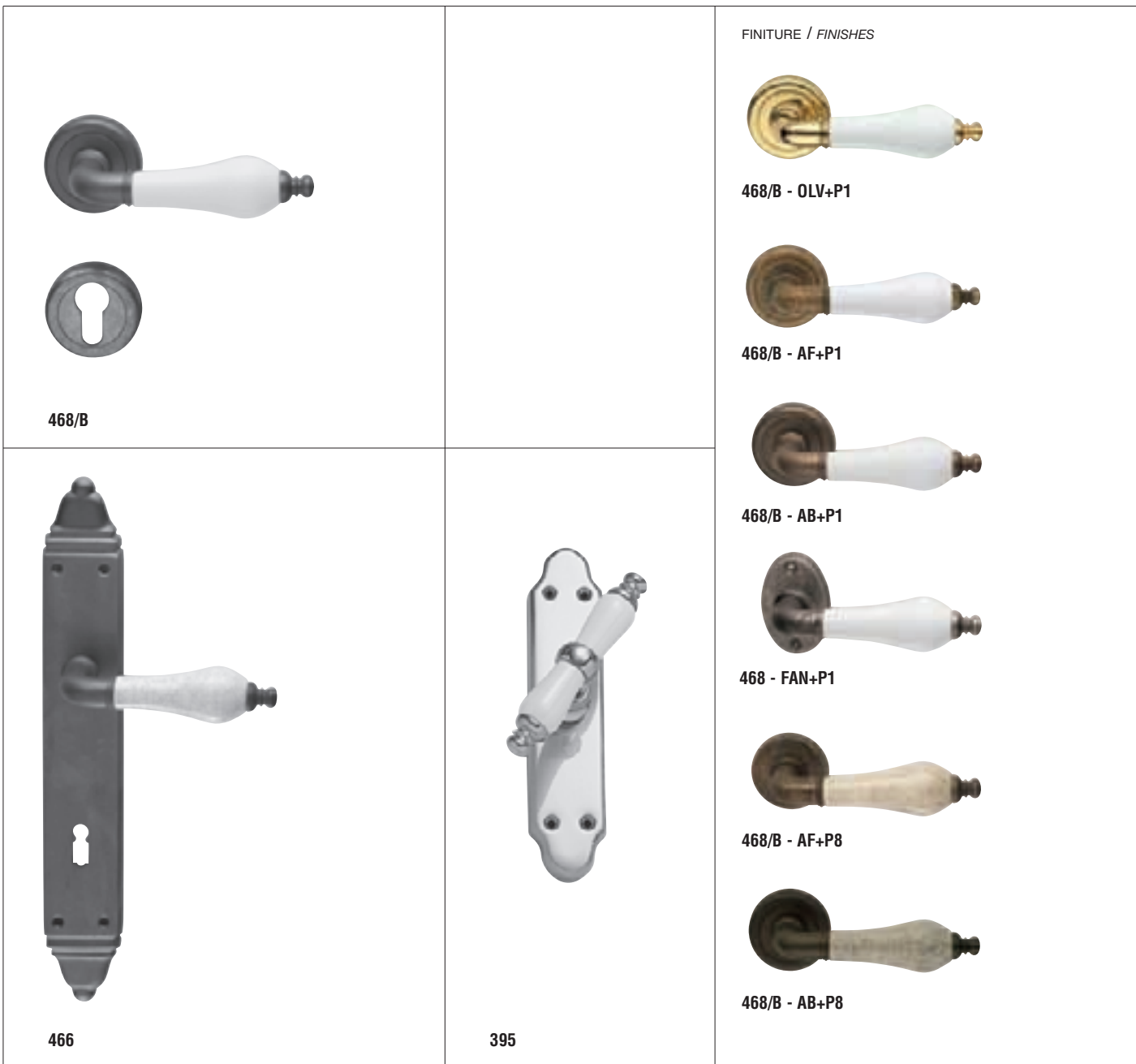

FINITURE / FINISHES



468/B - OLV+P1



468/B - AF+P1



468/B - AB+P1



468 - FAN+P1



468/B - AF+P8



468/B - AB+P8

468/B

466

395

**466**

Maniglia su placca Doria  
*Door handle on Doria plate*

**468/B**

Maniglia su rosetta e bocchetta  
ottone bombata 50 mm  
*Door handle on rounded brass rose  
and escutcheon 50 mm*

**468**

Maniglia su rosetta e bocchetta ovale  
*Door handle on oval rose  
and escutcheon*

**394**

Cremonese con meccanismo  
*Window handle with mechanism*

**395**

Martellina q.7 senza meccanismo  
*Window handle 7 mm square  
without mechanism*

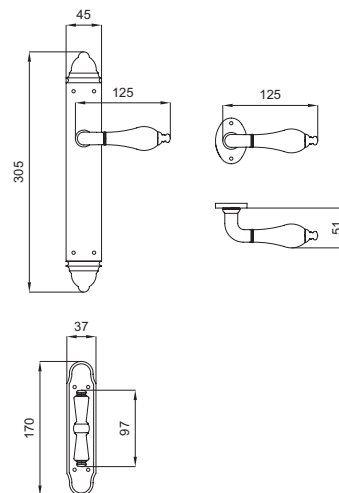

FINITURE / FINISHES

OLV+P1 - AF+P1 - AB+P1  
FAN+P1 - AF+P8 - AB+P8

# MONICA

**martinelli**  
HANDLES WITH CARE



**468/B OLV+P1**

Maniglia su rosetta e bocchetta ottone bombata 50 mm  
*Door handle on rounded brass rose and escutcheon 50 mm*

# MONICA

 <p><b>746</b></p>	 <p><b>747</b></p>	<p>FINITURE / FINISHES</p>  <p><b>746 - OLV</b></p>  <p><b>746 - OC</b></p>  <p><b>746/5 - OCS</b></p>
 <p><b>745</b></p>	<p><b>395</b></p>	

**745**  
 Maniglia su placca  
 Door handle on plate

**746**  
 Maniglia su rosetta e bocchetta  
 nylon 45 mm  
 Door handle on nylon rose  
 and escutcheon 45 mm

**746/5**  
 Maniglia su rosetta e bocchetta  
 nylon 50 mm  
 Door handle on nylon rose  
 and escutcheon 50 mm

**747**  
 Martellina DK  
 DK window handle

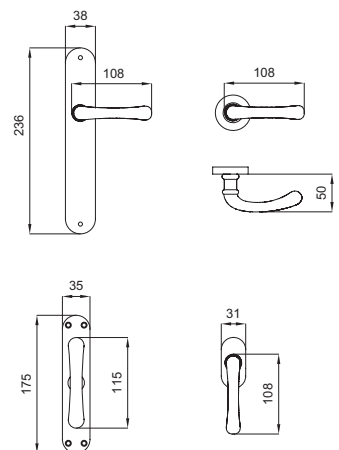

FINITURE / FINISHES  
**OLV - OC - OCS**

# ROSY

**martinelli**  
HANDLES WITH CARE



**746 OLV**

Maniglia su rosetta e bocchetta nylon 45 mm

*Door handle on nylon rose and escutcheon 45 mm*

ROSY

# KRISTINA

Materiale: ottone - solid brass

**martinelli**  
HANDLES WITH CARE

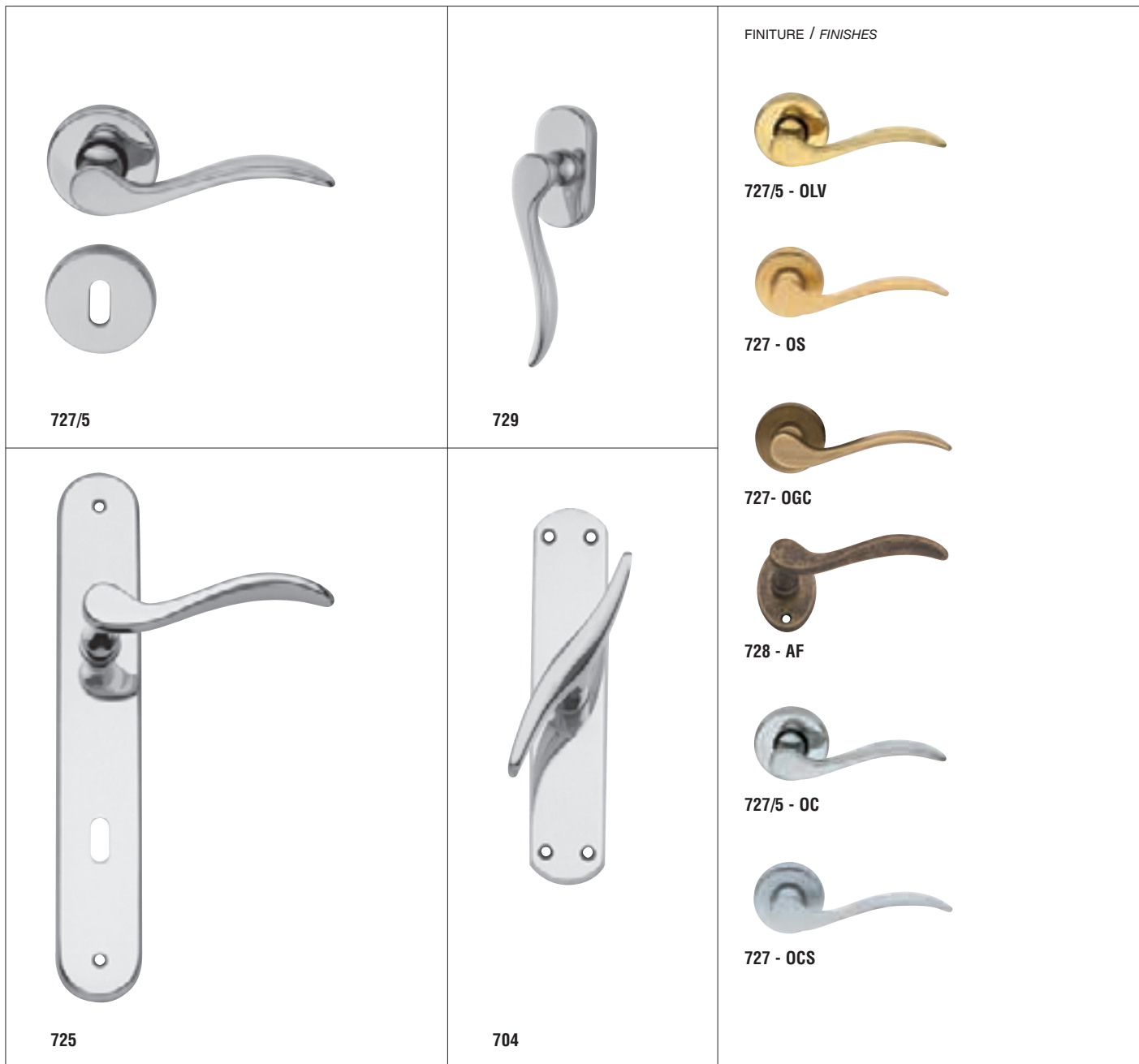

**725**

Maniglia su placca Sabina  
*Door handle on Sabina plate*

**726**

Maniglia su placca Noxia  
*Door handle on Noxia plate*

**731**

Maniglia su placca Vienna  
*Door handle on Vienna plate*

**727**

Maniglia su rosetta e bocchetta  
nylon 45 mm  
*Door handle on nylon rose  
and escutcheon 45 mm*

**727/5**

Maniglia su rosetta e bocchetta  
nylon 50 mm  
*Door handle on nylon rose  
and escutcheon 50 mm*

**728**

Maniglia su rosetta e bocchetta ovale  
*Door handle on oval rose  
and escutcheon*

**703**

Cremonese con meccanismo  
*Window handle with mechanism*

**704**

Martellina q.7 senza meccanismo  
*Window handle 7 mm square  
without mechanism*

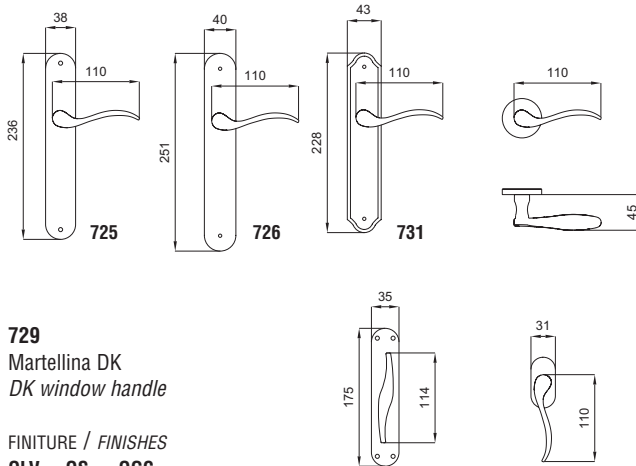

**729**

Martellina DK  
*DK window handle*

FINITURE / FINISHES

OLV - OS - OGC

AF - OC - OCS

# KRISTINA

**martinelli**  
HANDLES WITH CARE

DESIGN:  
MARTINELLI LAB



**727/5 OLV**

Maniglia su rosetta e bocchetta nylon 50 mm  
*Door handle on nylon rose and escutcheon 50 mm*

# KRISTINA

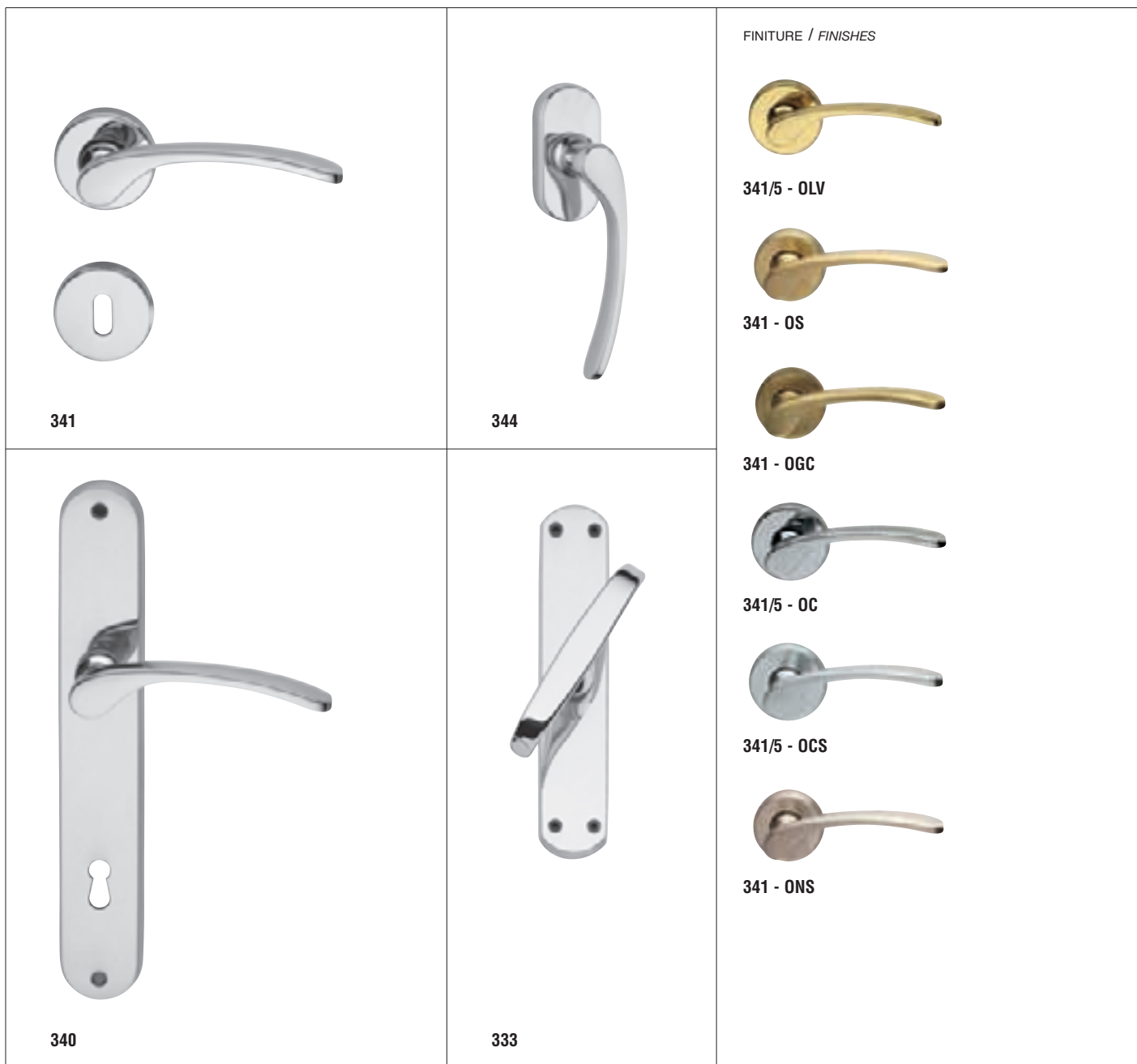

**340**  
Maniglia su placca Sabina  
*Door handle on Sabina plate*

**346**  
Maniglia su placca Noxia  
*Door handle on Noxia plate*

**342**  
Maniglia su placca Arcadia  
*Door handle on Arcadia plate*

**341**  
Maniglia su rosetta e bocchetta  
nylon 45 mm  
*Door handle on nylon rose  
and escutcheon 45 mm*

**341/5**  
Maniglia su rosetta e bocchetta  
nylon 50 mm  
*Door handle on nylon rose  
and escutcheon 50 mm*

**332**  
Cremonese con meccanismo  
*Window handle with mechanism*

**333**  
Martellina q.7 senza meccanismo  
*Window handle 7 mm square  
without mechanism*

**344**  
Martellina DK  
*DK window handle*

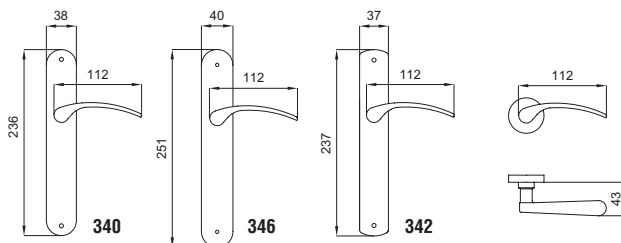

**335**  
Martellina su rosetta ovale R011  
*Window handle on R011  
oval rose*

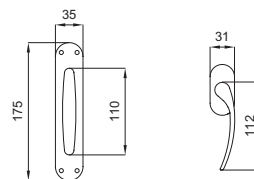

FINITURE / FINISHES  
**OLV - OS - OGC**  
**OC - OCS - ONS**



# LAURA

**martinelli**  
HANDLES WITH CARE



**341 OC**

Maniglia su rosetta e bocchetta nylon 45 mm  
*Door handle on nylon rose and escutcheon 45 mm*

# LAURA



FINITURE / FINISHES

-  331 - OLV
-  331 - OS
-  331 - OGC
-  331/5 - OC
-  331 - OCS
-  331 - ONS

**330**  
Maniglia su placca Sabina  
*Door handle on Sabina plate*

**336**  
Maniglia su placca Noxia  
*Door handle on Noxia plate*

**329**  
Maniglia su placca Arcadia  
*Door handle on Arcadia plate*

**331**  
Maniglia su rosetta e bocchetta  
nylon 45 mm  
*Door handle on nylon rose  
and escutcheon 45 mm*

**331/5**  
Maniglia su rosetta e bocchetta  
nylon 50 mm  
*Door handle on nylon rose  
and escutcheon 50 mm*

**332**  
Cremonese con meccanismo  
*Window handle with mechanism*

**333**  
Martellina q.7 senza meccanismo  
*Window handle 7 mm square  
without mechanism*

**334**  
Martellina DK  
*DK window handle*

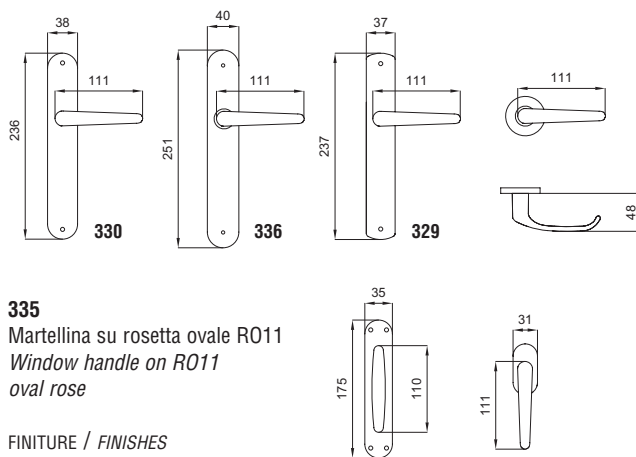

**335**  
Martellina su rosetta ovale RO11  
*Window handle on RO11  
oval rose*

FINITURE / FINISHES  
OLV - OS - OGC  
OC - OCS - ONS

# NINA

**martinelli**  
HANDLES WITH CARE



**331 OS**

Maniglia su rosetta e bocchetta nylon 45 mm

*Door handle on nylon rose and escutcheon 45 mm*

NINA

# PRELUDE

Materiale: ottone - solid brass



FINITURE / FINISHES



752 - OLV



752/5 - OS



752 - OGC



752 - OC



752 - OCS

752

753

751

333

**750**  
maniglia su placca Sabina  
door handle on Sabina plate

**751**  
maniglia su placca Arcadia  
door handle on Arcadia plate

**752**  
maniglia su rosetta e bocchetta  
nylon 45 mm  
door handle on nylon rose  
and escutcheon 45 mm

**752/5**  
maniglia su rosetta e bocchetta  
nylon 50 mm  
door handle on nylon rose  
and escutcheon 50 mm

**332**  
cremonese con meccanismo  
window handle with mechanism

**333**  
martellina q.7 senza meccanismo  
window handle 7 mm square  
without mechanism

**753**  
martellina DK  
DK window handle

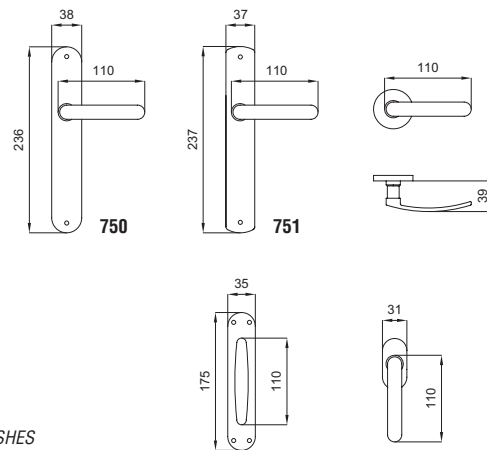

FINITURE / FINISHES  
OLV - OS - OGC - OC - OCS

# PRELUDE

**martinelli**  
HANDLES WITH CARE



**752 OCS**

Maniglia su rosetta e bocchetta nylon 45 mm

*Door handle on nylon rose and escutcheon 45 mm*

PRELUDE

# MELODY

Materiale: ottone - solid brass

**martinelli**  
HANDLES WITH CARE

 <p><b>581/B</b></p>	 <p><b>584</b></p>	<p>FINITURE / FINISHES</p>  <p><b>581/B - LRC</b></p>  <p><b>582/5 - LPI</b></p>
 <p><b>580</b></p>		

**580**  
Maniglia su placca  
*Door handle on plate*

**581/B**  
Maniglia su rosetta e bocchetta  
ottone bombata 50 mm  
*Door handle on rounded brass rose  
and escutcheon 50 mm*

**582/5**  
Maniglia su rosetta e bocchetta  
nylon 50 mm  
*Door handle on nylon rose  
and escutcheon 50 mm*

**584**  
Martellina DK  
*DK window handle*

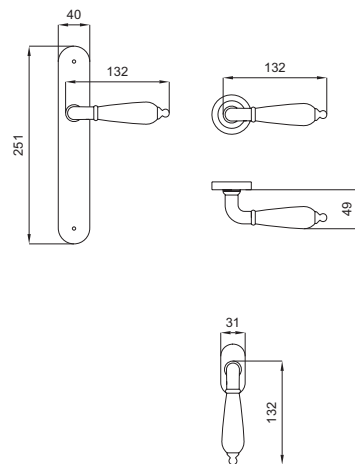

FINITURE / FINISHES  
**LRC - LPI**

# MELODY

**martinelli**  
HANDLES WITH CARE



**581/B LRC**

Maniglia su rosetta e bocchetta ottone bombata 50 mm  
*Door handle on rounded brass rose and escutcheon 50 mm*

DESIGN:  
MARTINELLI LAB

# MELODY



FINITURE / FINISHES



371 - OLV



371 - OGR

371

375

560

373

**370/V**

Maniglia su placca Vienna  
Door handle on Vienna plate

**560**

Maniglia su placca Classic  
Door handle on Classic plate

**371**

Maniglia su rosetta e bocchetta  
ottone 50 mm  
Door handle on brass rose  
and escutcheon 50 mm

**372**

Cremonese con meccanismo  
Window handle with mechanism

**373**

Martellina q.7 senza meccanismo  
Window handle 7mm square  
without mechanism

**375**

Martellina DK  
DK window handle

**355**

Martellina su rosetta ovale R011  
Window handle on R011  
oval rose

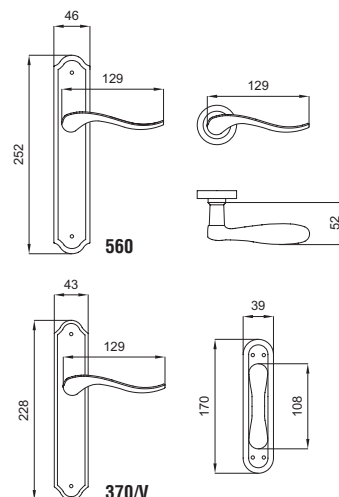

FINITURE / FINISHES  
OLV - OGR



# ELEGANT

**martinelli**  
HANDLES WITH CARE

DESIGN:  
MARTINELLI LAB



**371 OLV**

Maniglia su rosetta e bocchetta ottone 50 mm  
*Door handle on brass rose and escutcheon 50 mm*

# ELEGANT



FINITURE / FINISHES



402 - OLV



401 - AF



402 - OGH



401 - FAN



402 - SIL

**400**  
Maniglia su placca Daniela  
*Door handle on Daniela plate*

**469**  
Maniglia su placca Doria  
*Door handle on Doria plate*

**459**  
Maniglia su placca Zurigo  
senza molla  
*Door handle on Zurigo plate  
without spring*

**402**  
Maniglia su rosetta e bocchetta  
ottone 50 mm  
*Door handle on brass rose  
and escutcheon 50 mm*

**401**  
Maniglia su rosetta e bocchetta ovale  
*Door handle on oval rose  
and escutcheon*

**403**  
Cremonese con meccanismo  
*Window handle with mechanism*

**404**  
Martellina q.7 senza meccanismo  
*Window handle 7 mm square  
without mechanism*

**405**  
Martellina DK  
*DK window handle*

**406**  
Martellina su rosetta ovale RO11  
*Window handle on RO11  
oval rose*

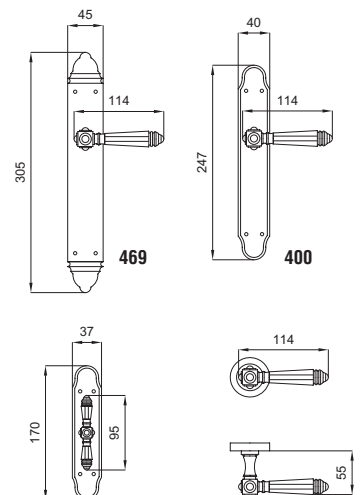









FINITURE / FINISHES  
OLV - OGC - AF  
OGH - FAN - SIL



**402 OGH**

Maniglia su rosetta e bocchetta ottone 50 mm  
*Door handle on brass rose and escutcheon 50 mm*

 <p><b>775/B</b></p>	 <p><b>778</b></p>	<p>FINITURE / FINISHES</p>  <p><b>775/B - OLV</b></p>  <p><b>775/B - OGC</b></p>  <p><b>775/B - AF</b></p>  <p><b>775/B - OBV</b></p>  <p><b>775/B - FAN</b></p>  <p><b>775/B - SIL</b></p>
 <p><b>773</b></p>		

**773**  
 Maniglia su placca Classic  
 Door handle on Classic plate

**774**  
 Maniglia su placca Vienna  
 Door handle on Vienna plate

**775/B**  
 Maniglia su rosetta e bocchetta  
 ottone bombata 50 mm  
 Door handle on rounded brass rose  
 and escutcheon 50 mm

**778**  
 Martellina DK  
 DK window handle

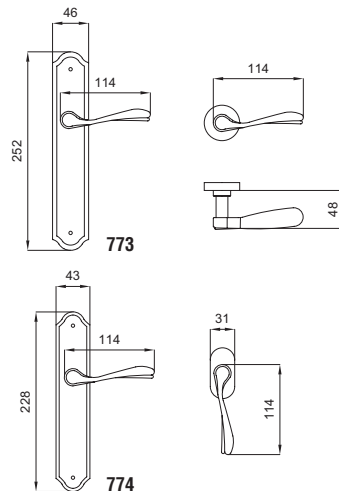

FINITURE / FINISHES  
**OLV - OGC - AF - OBV**  
**OGH - FAN - SIL**



**775/B SIL**

Maniglia su rosetta e bocchetta ottone bombata 50 mm

*Door handle on rounded brass rose and escutcheon 50 mm*

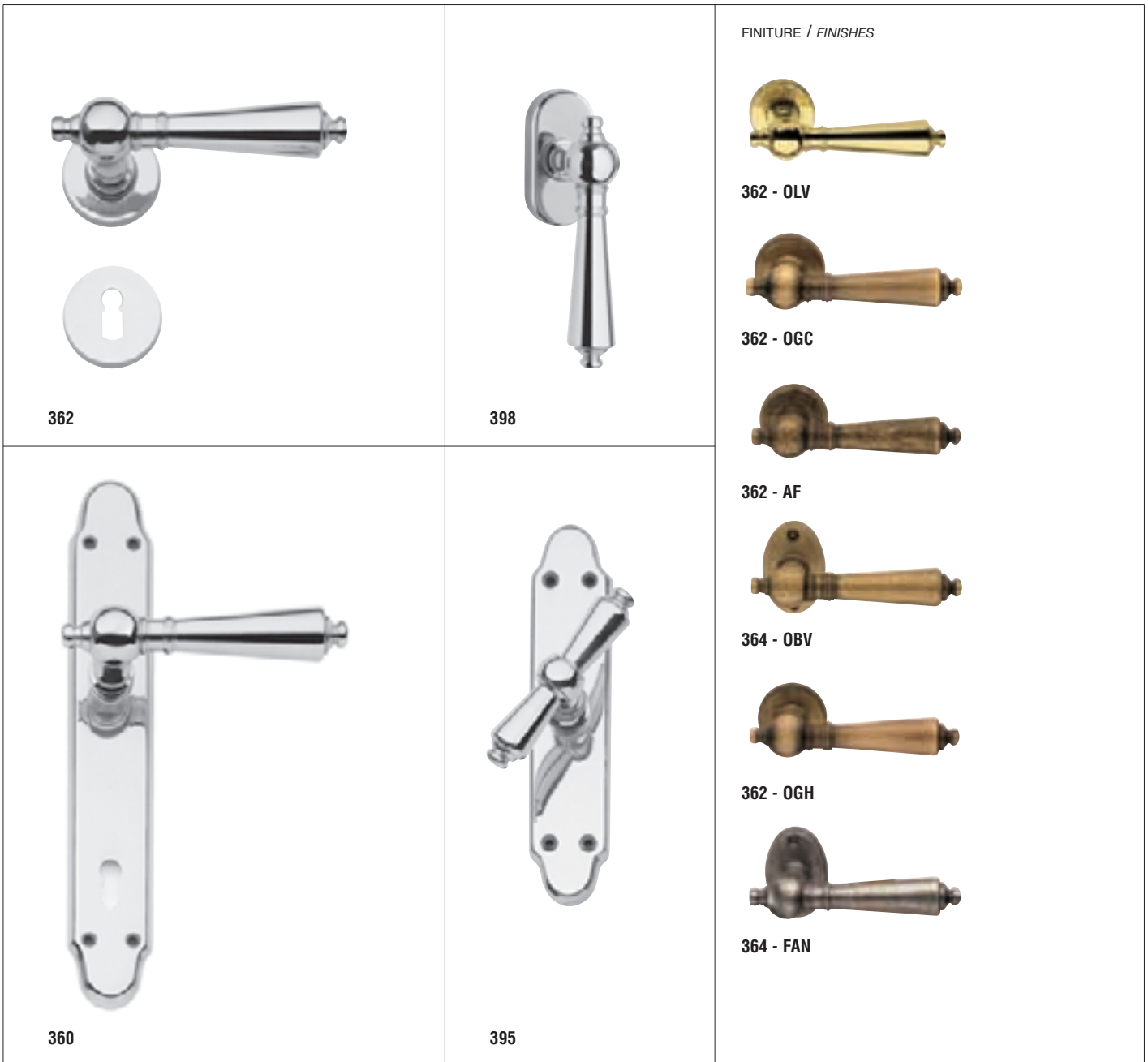

**360**  
Maniglia su placca Daniela  
*Door handle on Daniela plate*

**470**  
Maniglia su placca Doria  
*Door handle on Doria plate*

**362**  
Maniglia su rosetta e bocchetta  
nylon 45 mm  
*Door handle on nylon rose  
and escutcheon 45 mm*

**362/5**  
Maniglia su rosetta  
e bocchetta nylon 50 mm  
*Door handle on nylon rose  
and escutcheon 50 mm*

**364**  
Maniglia su rosetta e bocchetta ovale  
*Door handle on oval rose  
and escutcheon*

**394**  
Cremonese con meccanismo  
*Window handle with mechanism*

**395**  
Martellina q.7 senza meccanismo  
*Window handle 7 mm square  
without mechanism*

**398**  
Martellina DK  
*DK window handle*

**397**  
Martellina su rosetta ovale RO11  
*Window handle on RO11  
oval rose*

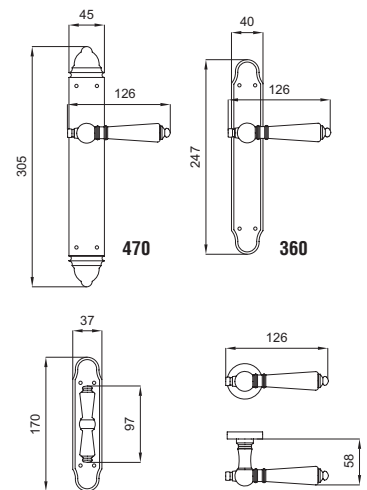

FINITURE / FINISHES  
**OLV - OGC - AF - OBV  
OGH - FAN - SIL**

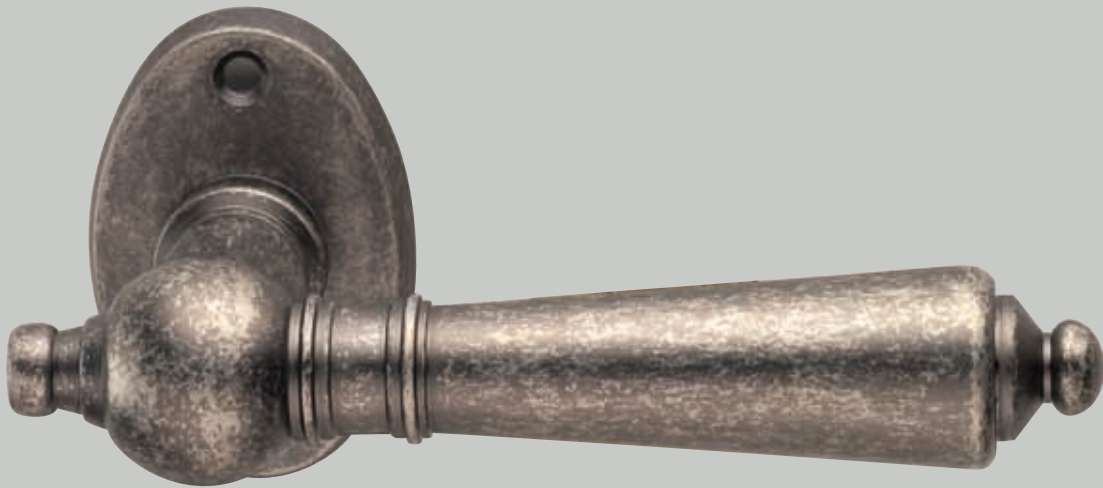

**364 FAN**

Maniglia su rosetta e bocchetta ovale  
*Door handle on oval rose and escutcheon*

# DORIA

Materiale: ottone - solid brass

**martinelli**  
HANDLES WITH CARE

Articoli prodotti su ordinazione. Per maggiori informazioni contattare l'azienda.

Articles produced on demand only. Contact us for more informations.

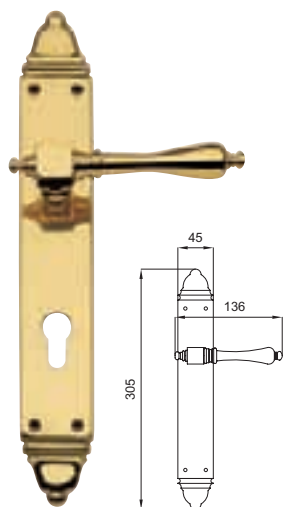

**472**  
Maniglia su placca  
*Door handle on plate*

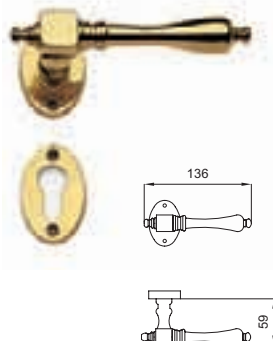

**471**  
Maniglia su rosetta  
e bocchetta ovale  
*Door handle on oval rose  
and escutcheon*

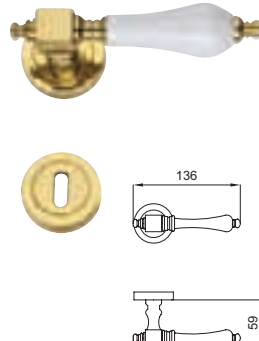

**474**  
Maniglia su rosetta  
e bocchetta ottone 50 mm  
*Door handle on brass rose  
and escutcheon 50 mm*

FINITURE / FINISHES



**OLV**



**AF**



**AB+P1**



**AF+P8**

**486**  
Martellina DK  
*DK window handle*

FINITURE / FINISHES: OLV - OGC - AF - OLV+P1 - AB+P1 - AB+P8 - AF+P8

# VENERE

Articoli prodotti su ordinazione. Per maggiori informazioni contattare l'azienda.

Articles produced on demand only. Contact us for more informations.

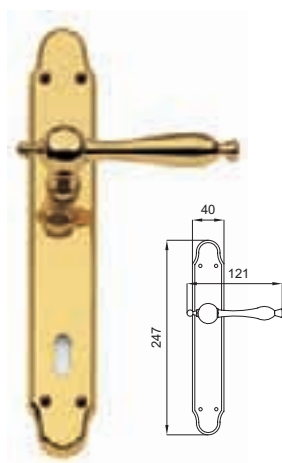

**380**  
Maniglia su placca  
*Door handle on plate*

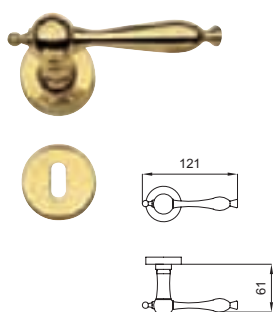

**381**  
Maniglia su rosetta  
e bocchetta nylon 45 mm  
*Door handle on nylon rose  
and escutcheon 45 mm*

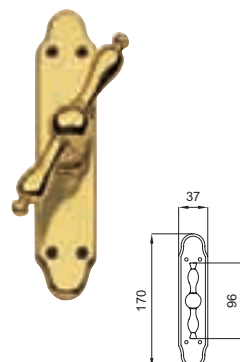

**382**  
Cremonese con meccanismo  
*Window handle with mechanism*

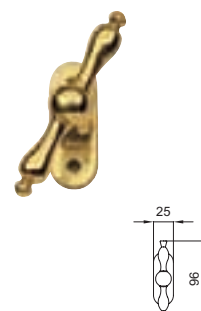

**385**  
Martellina su rosetta ovale R011  
*Window handle on R011 oval rose*

**383**  
Martellina q.7 senza meccanismo  
*Window handle 7 mm square without  
mechanism*

FINITURE / FINISHES: OLV - OGR



Articoli prodotti su ordinazione. Per maggiori informazioni contattare l'azienda.

Articles produced on demand only. Contact us for more informations.

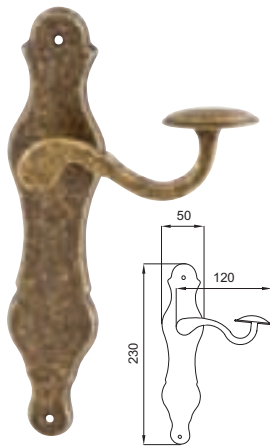

**455**  
Maniglia su placca Paperino  
Door handle on Paperino plate

FINITURE / FINISHES: **OLV - AF**

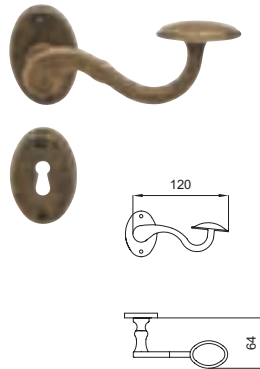

**456**  
Maniglia su rosetta  
e bocchetta ovale  
Door handle on oval rose  
and escutcheon

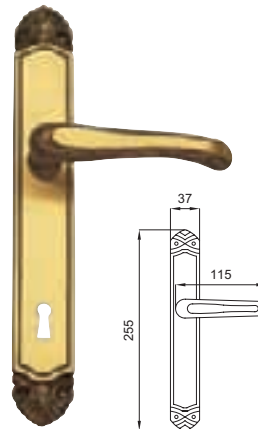

**490**  
Maniglia su placca  
Door handle on plate

FINITURE / FINISHES: **OBS**

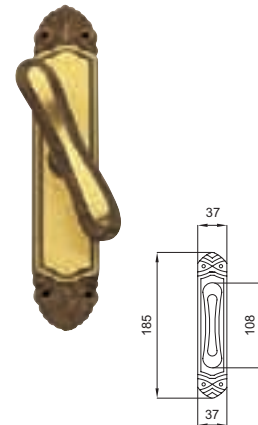

**494**  
Cremonese con meccanismo  
Window handle with mechanism

# SIRIA

Articoli prodotti su ordinazione. Per maggiori informazioni contattare l'azienda.

Articles produced on demand only. Contact us for more informations.

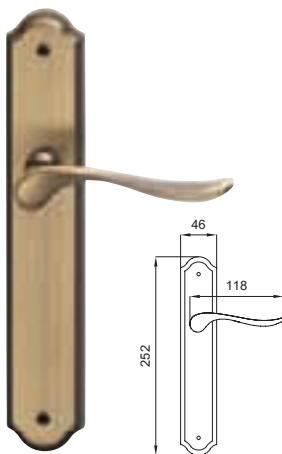

**561**  
Maniglia su placca Classic  
Door handle on Classic plate

FINITURE / FINISHES: **OLV - OGC**

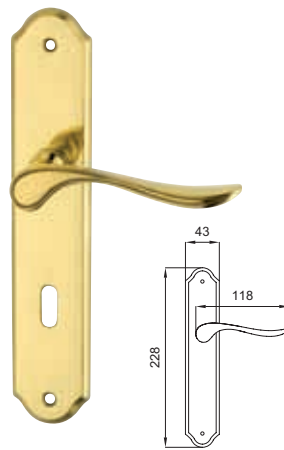

**350/V**  
Maniglia su placca Vienna  
Door handle on Vienna plate



**355**  
martellina su rosetta  
ovale R011  
window handle on R011  
oval rose

# LUNA

# ZURIGO

Materiale: ottone - solid brass

Articoli prodotti su ordinazione. Per maggiori informazioni contattare l'azienda.

Articles produced on demand only. Contact us for more informations.

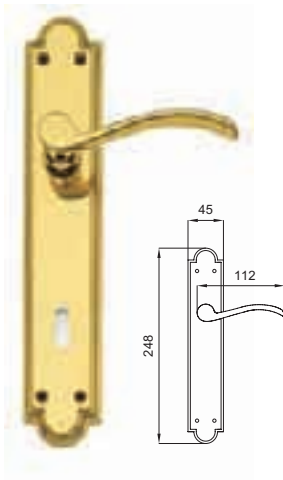

**477**  
Maniglia su placca  
Door handle on plate

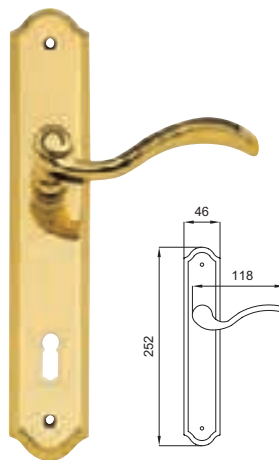

**562**  
Maniglia su placca Classic  
Door handle on Classic plate

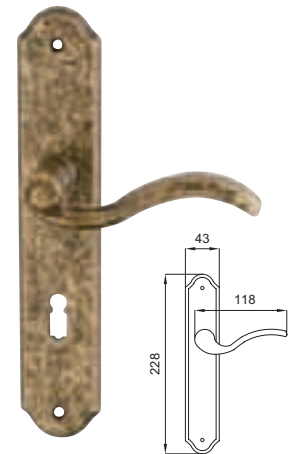

**464/V**  
Maniglia su placca Vienna  
Door handle on Vienna plate

FINITURE / FINISHES: OLV - AF - OGC - FAN

FINITURE / FINISHES: OLV - AF - OGR

# PAPERINO

Articoli prodotti su ordinazione. Per maggiori informazioni contattare l'azienda.

Articles produced on demand only. Contact us for more informations.

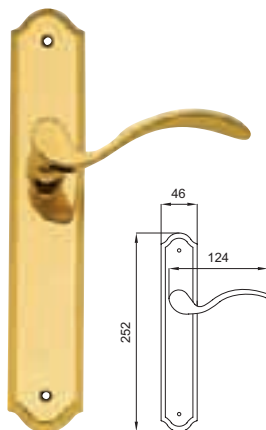

**564**  
Maniglia Paperino H  
su placca Classic  
Paperino H door handle  
on Classic plate

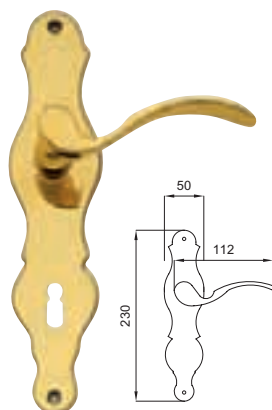

**449/H**  
Maniglia Paperino H  
su placca  
Paperino H door handle  
on plate

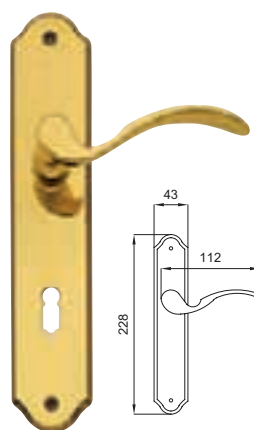

**451/H**  
Maniglia Paperino H  
su placca Vienna  
Paperino H door handle  
on Vienna plate

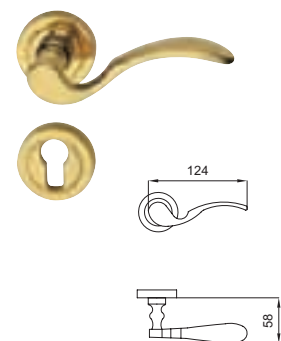

**447**  
Maniglia Paperino H su rosetta  
e bocchetta ottone 50 mm  
Paperino H door handle on brass  
rose and escutcheon 50 mm

FINITURE / FINISHES: OLV - OGR - AF - FAN

# COMBINAZIONI

*COMBINATIONS*



COMBINAZIONI

# COMBINAZIONI PARTICOLARI - COMBINATIONS

Esempi di maniglie su rosetta o placca con nottolino  
*Versions of door handles on roses or plates with turn & release*

**Combinazioni disponibili a richiesta sui nostri articoli**  
*The above combinations are available for our products on request*

**Esempi di ordine**  
*Examples of order*



**633 - 2282+A**  
Maniglia su rosetta e nottolino America nylon 45 mm chiusura "tipo A"  
*Door handle on nylon rose and America turn & release "A" 45 mm*



**576/B - 2284+A**  
Maniglia su rosetta e nottolino America ottone bombato 50 mm chiusura "tipo A"  
*Door handle on rounded brass rose and America turn & release "A" 50 mm*



**602 - 2278+A**  
Maniglia su rosetta e nottolino ottone 55 mm chiusura "tipo A"  
*Door handle on brass rose and turn & release "A" 55 mm*



**623/5 - 2273+A**  
Maniglia su rosetta e nottolino nylon 50 mm chiusura "tipo A"  
*Door handle on nylon rose and turn & release "A" 50 mm*



**311 - 2275+B**  
Maniglia su rosetta e nottolino ottone 50 mm chiusura "tipo B"  
*Door handle on brass rose and turn & release "B" 50 mm*



**623/S - 2292+B**  
Maniglia su rosetta e nottolino Scandinavia bombato 50 mm chiusura "tipo B"  
*Door handle on rounded brass rose and Scandinavia turn & release "B" 50 mm*



**140 - 2279+A**  
Maniglia su placca e nottolino chiusura "tipo A"  
*Door handle on plate and turn & release "A"*



**200 - 2279+B**  
Maniglia su placca e nottolino chiusura "tipo B"  
*Door handle on plate and turn & release "B"*

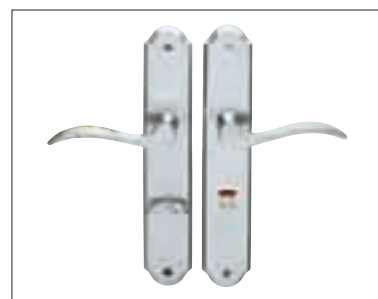

**723 - 2292+B**  
Maniglia su placca e nottolino Scandinavia chiusura "tipo B"  
*Door handle on plate and Scandinavia turn & release "B"*

# COMBINAZIONI PARTICOLARI - COMBINATIONS

**Combinazioni disponibili a richiesta sui nostri articoli**  
*The above combinations are available for our products on request*

**Esempi di ordine**  
*Examples of order*

Esempi di maniglie per porta d'ingresso  
*Versions of entry door set*

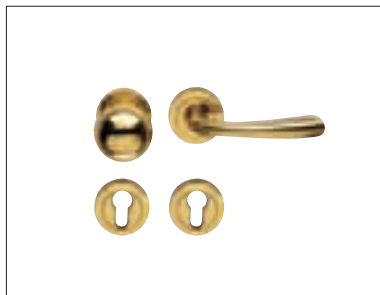

**622 WE/S**  
Maniglia con pomolo Sfera art. 1570-50 mm fisso e bocchette ottone foro Yale 50 mm  
*Door handle with 50 mm Sfera fixed knob art.1570-50 mm and Euro profile brass escutcheons 50 mm*



**633/5 WE/S**  
Maniglia con pomolo Sfera art. 1570-50 mm fisso e bocchette nylon foro Yale 50 mm  
*Door handle with 50 mm Sfera fixed knob art.1570-50 mm and nylon Euro profile escutcheons 50 mm*

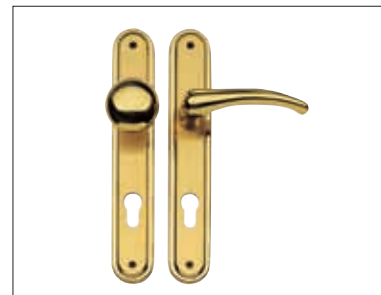

**210 WE/V**  
Maniglia su placca foro Yale con pomolo Victorian art. 1590-55 mm fisso  
*Door handle on Euro profile hole plate with 55 mm Victorian fixed knob art. 1590*



**AFER#800703**  
Ferro in dotazione per porta d'ingresso  
*Spindle supplied with the entry door set*



**AFER#80070N**  
Ferro disponibile su richiesta solo per pomolo art. 1570  
*Spindle supplied on request with entry door set but only for fixed knob Sfera art. 1570*

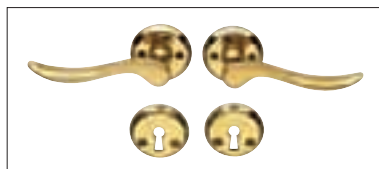

**727 - S**  
Set maniglia su rosette e bocchette scandinave  
*Door handle set on scandinavian standard roses & escutcheons*

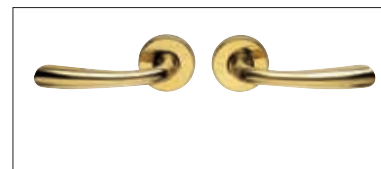

**623/5 - SB**  
set maniglie su rosetta senza bocchette  
*door handle set on roses without escutcheons*



**316 - R016**  
Maniglia su rosetta ovale nylon R016 con molla dx o sx  
*Door handle on oval nylon rose R016 left or right springloaded*

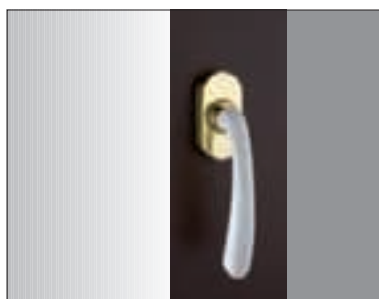

**625NY-P**  
Martellina DK con pellicola protettiva da rimuovere alla fine dei lavori di cantiere  
*DK window handle with protective film to be removed when building workings are completed*



Sistema per aste esterne disponibile per tutti i cremonesi

*External bars system available on all window handles*

**252/E**  
Cremonese su placca per aste esterne con passanti  
*Window handle on plate for external bars with accessories*

# SERIE GEORGIAN E VICTORIAN

## SERIE GEORGIAN & VICTORIAN RANGE

Il catalogo della serie completa Georgian e Victorian è disponibile su richiesta.  
*The catalogue for the complete Georgian and Victorian range is available on request.*



**MV105**



**MD122**



**MG116**



**MD163**



**MV121**



**MG104**

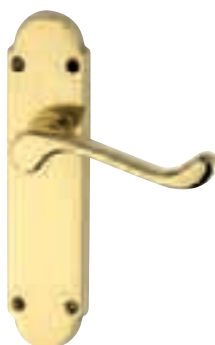

**MV 700**



**MD 184**



**MD 190**

# MANIGLIONI

*PULL HANDLES*



MANIGLIONI

# LATINA

DESIGN:  
MAURO RONCHI

ottone stampato a caldo - hot stamped brass

**martinelli**  
HANDLES WITH CARE



SIL



OGC



FAN

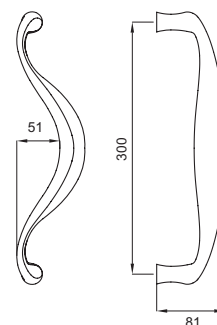

**1110**  
Maniglione 300 mm  
Pull handle 300 mm

**1111**  
Maniglione accoppiato 300 mm  
Pull handle set 300 mm

FINITURE / FINISHES:

OLV - OS - OGC - OBV  
OGH - BSS - FAN - SIL  
OC - OCS - ONS - PVD  
PVD INOX

# BEVERLY

Maniglione singolo - fissaggio non passante con piastrina - Pull handle: metal base fixing

Maniglione accoppiato - per porte in vetro, legno o metallo - Door pull handle set: through fixing for glass, wooden or metal doors



OLV



OGR

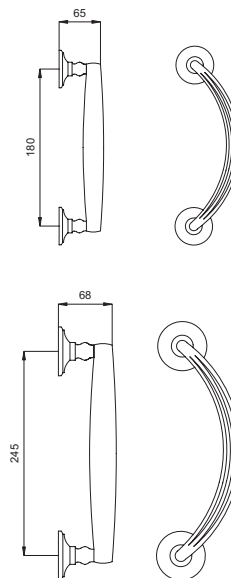

**1134**  
Maniglione 245 mm  
Pull handle 245 mm

**1136**  
Maniglione 180 mm  
Pull handle 180 mm

**1135**  
Maniglione accoppiato 245 mm  
Pull handle set 245 mm

**1137**  
Maniglione accoppiato 180 mm  
Pull handle set 180 mm

FINITURE / FINISHES:

OLV - OS - OGC - OGH  
FAN - SIL - PVD - PVD INOX



# ONLY

DESIGN:  
MAURO RONCHI

Materiale: ottone - *solid brass*



OLV

**1165**  
Maniglione non passante  
200 mm  
Pull handle 200 mm  
concealed fixing



OC

**1167**  
Maniglione passante 200 mm  
Pull handle 200 mm through  
fixing



OCS

**1166**  
Maniglione accoppiato 200 mm  
Pull handle set 200 mm



ONS



OS

FINITURE / FINISHES:  
OLV - OS - OGC - AF  
OGH - OC - OCS - ONS



# LIRICA



OLV

**1195**  
Maniglione 200 mm  
Pull handle 200 mm



OBV

**1196**  
Maniglione 250 mm  
Pull handle 250 mm



AF

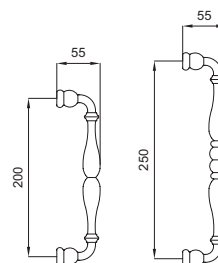

FINITURE / FINISHES:  
OLV - OGC - AF - OGH  
BSS - OBV - FAN - SIL

# THEA

Materiale: ottone - *solid brass*



AF



OLS



OLS

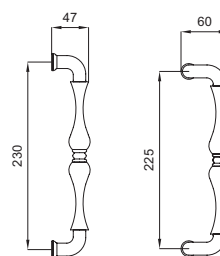

**1160**  
Maniglione 230 mm  
Pull handle 230 mm

**1174**  
Maniglione spostato 225 mm  
Projecting pull handle 225 mm

FINITURE / FINISHES:  
OLS - OGC - AF  
OGH - FAN - SIL

# COTTAGE

DESIGN:  
MARTINELLI LAB

# COTTAGE DUE



OLS

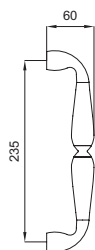

**1142**  
Maniglione 235 mm  
Pull handle 235 mm



CCS

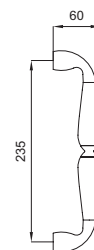

**1143**  
Maniglione 235 mm  
Pull handle 235 mm

FINITURE / FINISHES:  
OLS - CCS - CNS

# VENICE

DESIGN:  
PIETRO SILVA

# VENICE DUE

DESIGN:  
PIETRO SILVA



**OLS**

**1140**  
Maniglione 190 mm  
Pull handle 190 mm



**CCS**



**CCS**

**1141**  
Maniglione 190 mm  
Pull handle 190 mm

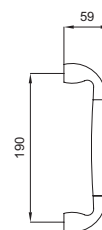

FINITURE / FINISHES:  
**OLS - CCS - CNS**

# DANIELA

Materiale: ottone - solid brass

**martinelli**  
HANDLES WITH CARE



FAN

**1150**  
Maniglione 205 mm  
Pull handle 205 mm



AF

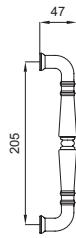

OLV

**1170**  
Maniglione spostato 195 mm  
Projecting pull handle 195 mm

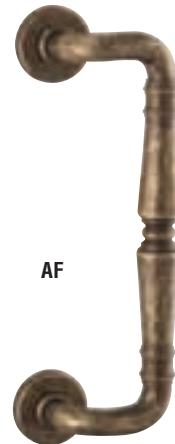

AF

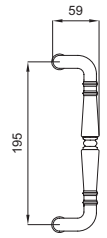

FINITURE / FINISHES:

OLV - OGC - AF - OGH  
OBV - FAN - SIL

# DANIELA PORCELLANA

# ELENA



OLV+P1

**1150**  
Maniglione 205 mm  
Pull handle 205 mm



AF+P6

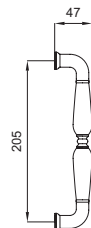

**1170**  
Maniglione spostato 195 mm  
Projecting pull handle 195 mm

FINITURE / FINISHES:

OLV+P1 - AF+P1 - FAN+P1  
AF+P6 - AB+P6 - OBV+P6  
AB+P8



OLV

**1163**  
Maniglietta 158 mm  
Short pull handle 158 mm



OCS



AF

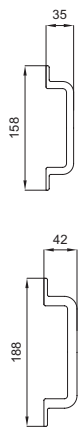

**1164**  
Maniglietta 188 mm  
Short pull handle 188 mm

FINITURE / FINISHES:

OLS - OGC - AF - AB  
OGH - OC - OCS - ONS

# ONDA

Materiale: ottone - solid brass

# COMETA



DESIGN:  
EMILIO CUPOLO



OLV

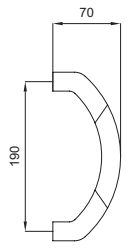



**1146**  
Maniglione 190 mm  
Pull handle 190 mm

FINITURE / FINISHES:  
OLV - OGC - OGH - AF  
OBV - FAN - SIL - PVD  
PVD INOX

DESIGN:  
EMILIO CUPOLO

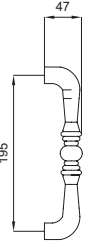

OLV

AF



FAN

**1145**  
maniglione 195 mm  
pull handle 195 mm

FINITURE / FINISHES:  
OLV - OGC - AF - OGH  
OBV - FAN - SIL - PVD  
PVD INOX

# DIANA

# SABINA



OLV



1182

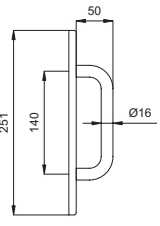
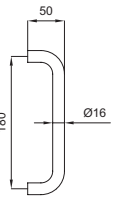

**1181**  
Maniglione 180 mm  
Pull handle 180 mm

**1182**  
Maniglione su placca  
Noxia 140 mm  
Pull handle 140 mm  
on Noxia plate

FINITURE / FINISHES:  
OLV - OS - OGR  
OC - OCS - ONS

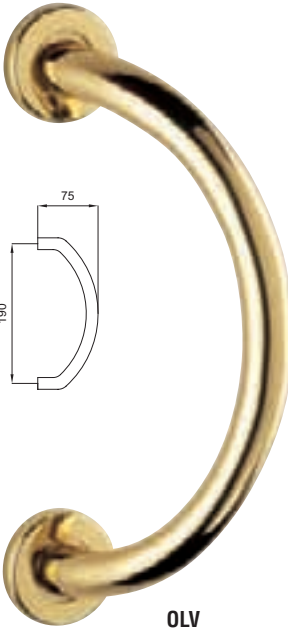

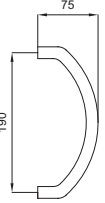
OLV

OGR



OCS

**1173**  
Maniglione 190 mm  
Pull handle 190 mm

FINITURE / FINISHES:  
OLV - OS - OGR  
OC - OCS - ONS

# POLO

Materiale: ottone - solid brass

# SARA



**1177**  
Maniglione 180 mm  
Pull handle 180 mm

**1178**  
Maniglione 230 mm  
Pull handle 230 mm

FINITURE / FINISHES:  
**OLS - CCS**

**1161**  
Maniglione 200 mm  
Pull handle 200 mm

**1171**  
Maniglione spostato  
190 mm  
Projecting pull handle  
190 mm

FINITURE / FINISHES:  
**OLS - CCS**

# BAROCCO

# KATY

\*altre misure disponibili a richiesta  
\*different sizes available on request

**1153**  
Maniglione 147 mm  
Pull handle 147 mm

FINITURE / FINISHES:  
**OLV - OGC - AF**  
**OGH - FAN**

**1156**  
Maniglione 185 mm  
Pull handle 185 mm

FINITURE / FINISHES:  
**OLV - OGC - AF**  
**OGH - FAN - SIL**

# SLIDE MANIGLIONE PER ALZANTE SCORREVOLE

ottone stampato a caldo - hot stamped brass

**martinelli**  
HANDLES WITH CARE



**1119**  
Maniglione singolo 250 mm  
placca cieca  
senza placchetta da incasso  
*Pull handle 250 mm  
on blind hole plate  
without sliding handle*

**1120**  
Maniglione singolo 250 mm  
placca cieca  
con placchetta da incasso  
*Pull handle 250 mm  
on blind hole plate  
with sliding door handle*

**1120Y**  
Maniglione singolo 250 mm  
placca f.yale  
con placchetta da incasso  
*Pull handle 250 mm  
on Euro profile hole plate  
with sliding door handle*

**1121**  
Maniglione accoppiato 250  
mm con placca f.yale  
*Pull handle set 250 mm on  
Euro profile hole plate*

**1122**  
Placchetta incasso singola  
*Sliding door handle*

FINITURE / FINISHES:

OLV - OS - OGC - AF  
AB - OGH - OC - OCS  
ONS - PVD - PVD INOX

modello depositato

DESIGN: MAURO RONCHI



**1124**  
Maniglione singolo 190 mm.  
placca cieca  
senza placchetta da incasso  
*Pull handle 190 mm.  
on blind hole plate  
without sliding handle*

**1125**  
Maniglione singolo 190 mm  
placca cieca  
con placchetta da incasso  
*Pull handle 190 mm  
on blind hole plate  
with sliding door handle*

**1125Y**  
Maniglione singolo 190 mm  
placca f.yale  
con placchetta da incasso  
*Pull handle 190 mm  
on Euro profile hole plate  
with sliding door handle*

**1126**  
Maniglione accoppiato 190  
mm con placca f.yale  
*Pull handle set 190 mm on Euro  
profile hole plate*

**1127**  
Maniglione 190 mm  
con movimento DK  
*DK pull handle 190 mm  
with mechanism*

FINITURE / FINISHES:

OLV - OS - OGC - AF  
AB - OGH - OC - OCS  
ONS - PVD - PVD INOX

modello depositato

madeinitaly

www.fmmartinelli.it





# POMOLI

*KNOBS*



POMOLI

**OCS**

**OLV**

**OC**

**A**

**B**

79

Ø70

**1560**  
Pomolo 70 mm  
Centre door knob 70 mm

*FINITURE / FINISHES*  
**OLV - OS - OGC - AF**  
**OGH - OC - OCS - ONS**  
**PVD - PVD INOX**

**Completo di due sistemi di fissaggio With two fixing systems**  
**A:** con vite passante - through fixing  
**B:** con base nylon e grano, non passante - nylon fixing base and grab screw

# SFERA

**1570 - ONS**

**1571 - OLV**

90  
80  
65

Ø60  
Ø70  
Ø60

**1570-60**  
Pomolo 60 mm con vite  
Centre door knob  
60 mm with screw

**1570-70**  
Pomolo 70 mm con vite  
Centre door knob 70 mm  
with screw

**1570-80**  
Pomolo 80 mm con vite  
Centre door knob  
80 mm with screw

**1570/1**  
Pomolo 70 mm  
con piastrina e grano  
Centre door knob 70 mm  
with metal fixing base  
and grab screw

**1571**  
Coppia pomolo 60 mm  
Mortice knob set 60 mm

*FINITURE / FINISHES*  
**OLV - OS - OGC - AF**  
**OGH - OC - OCS - ONS**  
**PVD - PVD INOX**

# DIAMANTE

Materiale: ottone - solid brass



**1572 - OLV**

**1572**  
Pomolo 70 mm con vite  
Centre door knob 70 mm  
with screw

**1572/1**  
Pomolo 70 mm  
con piastrina e grano  
Centre door knob 70 mm  
with metal fixing base  
and grab screw



**1573/C - OGR**



**1573 - OLV**

**1573**  
Coppia pomolo 50 mm  
Mortice knob set 50 mm

**1573/C**  
Coppia pomolo 50 m  
su rosetta ottone 42 mm  
Mortice knob set 50 mm  
on brass rose 42 mm

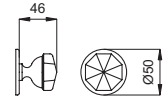
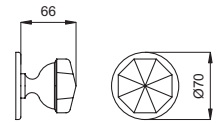

FINITURE / FINISHES  
**OLV - OGC - AF**  
**OGH - FAN**

# LORENA



**OGC**

**1569**  
Pomolo 70 mm con vite  
Centre door knob 70 mm with screw

**1569/1**  
Pomolo 70 mm con piastrina e grano  
Centre door knob 70 mm with metal  
fixing base and grab screw

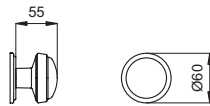
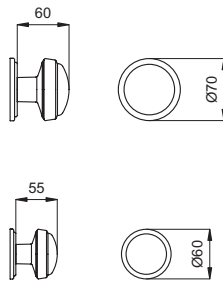

**OLV**

FINITURE / FINISHES  
**OLV - OGC**

# GEORGIAN

Materiale: ottone - solid brass



OLV

**1588**  
Pomolo 62 mm con vite  
*Centre door knob 62 mm with screw*



OLV

**1589**  
Coppia pomolo 55 mm  
*Mortice knob set 55 mm*

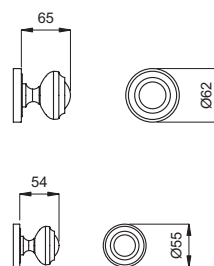

FINITURE / FINISHES

OLV - OGC

# VICTORIAN



OCS

**1590**  
Coppia pomolo 55 mm  
*Mortice knob set 55 mm*

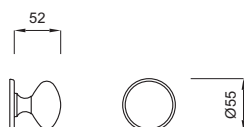

OLV

**1590/1**  
Pomolo fisso con fori a vista  
55 mm  
*Centre door knob 55 mm  
face fixing*



OC

FINITURE / FINISHES  
OLV - OS - OGC - OGH  
OC - OCS - ONS

# MARGHERITA

Materiale: ottone - solid brass

**martinelli**  
HANDLES WITH CARE



**OGC**

**1580**

Pomolo 70 mm con vite  
Centre door knob 70 mm with screw



**OLV**

**1581**

Coppia pomolo 55 mm  
Mortice knob set 55 mm



**OGC**

FINITURE / FINISHES

**OLV - OGC**

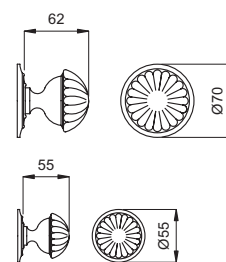



# BATTENTI

*DOOR - KNOCKERS*



BATTENTI

# LEONE

Materiale: ottone - solid brass



OLV

**2152**  
Battente grande  
*Big door knocker*  
240x140 mm



OLV

**2152-2**  
Battente medio  
*Medium door knocker*  
190x110 mm

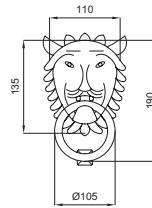
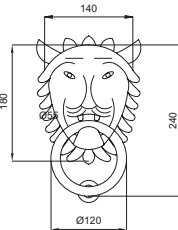

**2152-1**  
Battente piccolo  
*Small door knocker*  
150x90 mm



**2153**  
Leoncino con pulsante  
*Bell push*

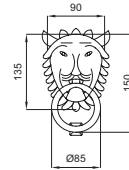

FINITURE / FINISHES  
OLV - OGC - AF  
OGH - PVD - PVD INOX

# BAROCCO

# ESAGONO



AF

**2150**  
Battente grande  
*Big door knocker*  
150x150 mm

**2150/1**  
Battente piccolo  
*Small door knocker*  
120x115 mm

FINITURE / FINISHES  
OLV - OGC - AF  
PVD - PVD INOX

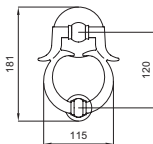
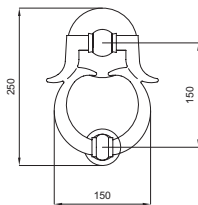

OLV

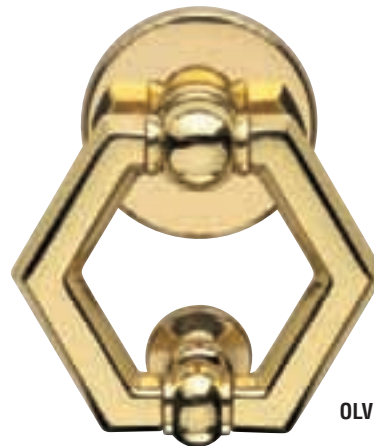

OLV

**2151/1**  
Battente grande  
*Big door knocker*  
120x104 mm

**2151**  
Battente piccolo  
*Small door knocker*  
100x95 mm

FINITURE / FINISHES  
OLV - OGC - AF

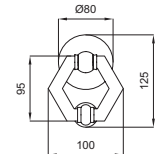
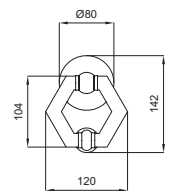

AF



OGC



# AMERICA

Materiale: ottone - solid brass

# ANELLO



OLV

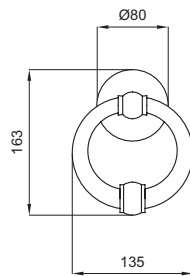

**2158**  
Battente  
Door knocker  
Ø 135 mm

FINITURE / FINISHES  
OLV - OGC - AF  
PVD - PVD INOX



OLV

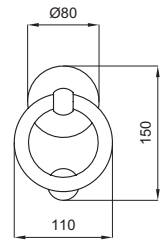

**2155/1**  
Battente grande  
Big door knocker  
Ø 130 mm

**2155**  
Battente piccolo  
Small door knocker  
Ø 110 mm

FINITURE / FINISHES  
OLV - OGC - AF  
PVD - PVD INOX

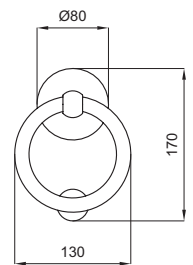

# VICTORIAN

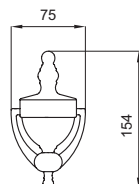
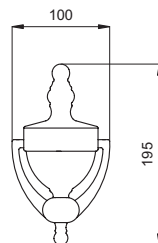

**2154/1**  
Battente grande  
Big door knocker  
195x100 mm

**2154**  
Battente piccolo  
Small door knocker  
154x75 mm

FINITURE / FINISHES  
OLV - OGC  
AF - OCS



OCS

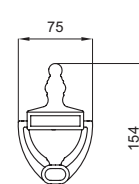
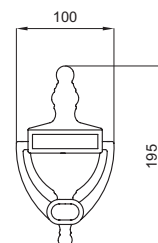

**2140/1**  
Battente grande  
Big door knocker  
195x100 mm

**2140**  
Battente piccolo  
Small door knocker  
154x75 mm

FINITURE / FINISHES  
OLV - OGC - AF



OLV

# GEORGIAN



# ACCESSORI

PER SCORREVOLI

*SLIDING DOOR ACCESSORIES*





ACCESSORI

Materiale: ottone - solid brass

<p><b>2191</b></p>	<p><b>2193</b></p>	<p><b>2191</b> Frontale per scorrevole <i>Sliding door flush pull hole</i></p> <p><b>2193</b> Rosetta incasso <i>Sliding door handle</i></p> <p><i>FINITURE / FINISHES:</i> <b>OLV - OGC - AF - OC - OCS - ONS</b></p>
<p><b>2193/S1</b></p>	<p><b>2193/F</b></p>	<p><b>2193/S1</b> Set rosette incasso con frontale <i>Sliding door handle set with flush pull hole</i></p> <p><b>2193/F</b> Rosetta incasso con foro chiave <i>Sliding door handle with key hole</i></p> <p><i>FINITURE / FINISHES:</i> <b>OLV - OGC - AF - OC - OCS - ONS</b></p>
<p><b>2193/F105</b></p>	<p><b>2193/F105K</b></p>	<p><b>2193/F105</b> Set rosette incasso con foro chiave con serratura e chiave snodata <i>Sliding door handle set with lock and jointed key</i></p> <p><i>FINITURE / FINISHES:</i> <b>OLV - OGC - AF - OC - OCS - ONS</b></p> <p><b>2193/F105K</b> Set rosette incasso con foro chiave con serratura e chiave snodata e frontale <i>Sliding door handle set with lock and jointed key and flush pull hole</i></p> <p><i>FINITURE / FINISHES:</i> <b>OLV - OGC - AF - OC - OCS - ONS</b></p>
<p><b>2194/S</b></p>		<p><b>2194/S</b> Set rosette incasso con nottolino ferro q.8 <i>Sliding door handle set with turn &amp; release 8 mm sq. spindle</i></p> <p><i>FINITURE / FINISHES:</i> <b>OLV - OGC - AF - OC - OCS - ONS</b></p>

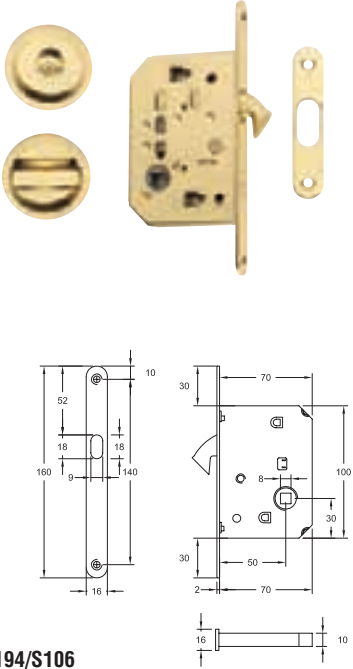
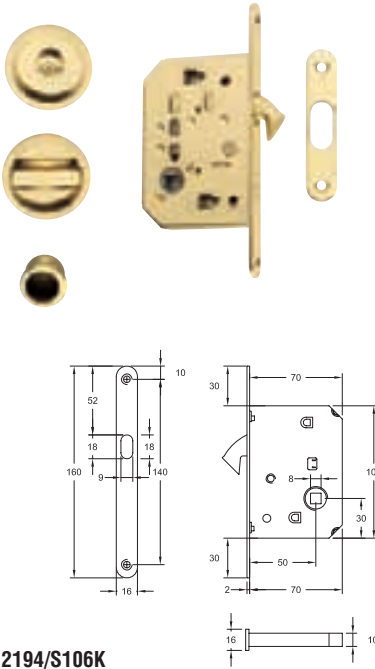
Materiale: ottone - solid brass

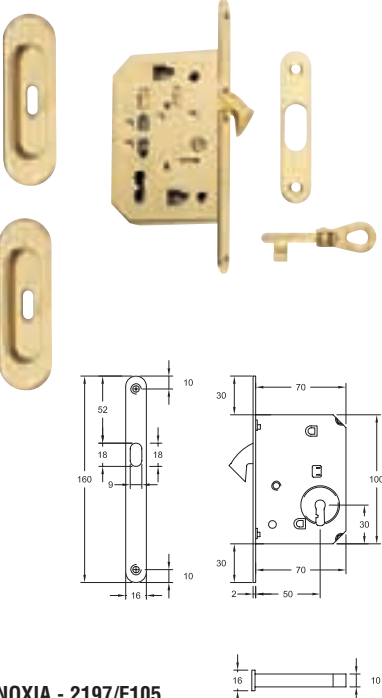
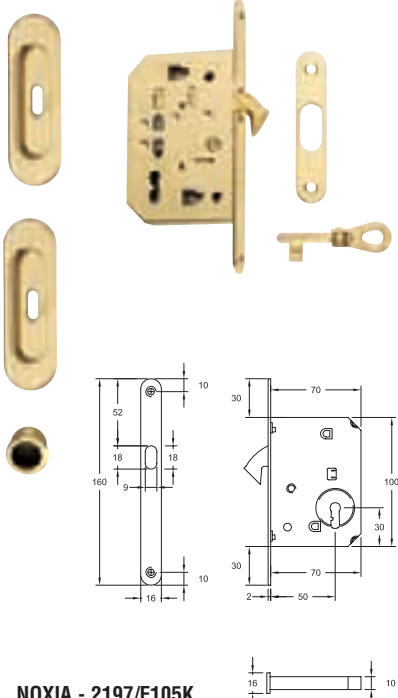
 <p><b>2194/S106</b></p>	 <p><b>2194/S106K</b></p>	<p><b>2194/S106</b> Set rosette incasso con nottolino ferro q.8 con serratura <i>Sliding door handle set with turn &amp; release 8 mm sq. spindle with lock</i></p> <p>FINITURE / FINISHES: <b>OLV - OGC - AF - OC - OCS - ONS</b></p> <p><b>2194/S106K</b> Set rosette incasso con nottolino ferro q.8 con serratura e frontale <i>Sliding door handle set with turn &amp; release 8 mm sq. spindle with lock and flush pull hole</i></p> <p>FINITURE / FINISHES: <b>OLV - OGC - AF - OC - OCS - ONS</b></p>
 <p><b>NOXIA - 2197/S1</b></p>		<p><b>NOXIA - 2197/S1</b> Set placchette incasso con frontale <i>Sliding door handle set with flush pull hole</i></p> <p>FINITURE / FINISHES: <b>OLV - OGC - AF - OC - OCS - ONS</b></p>
 <p><b>NOXIA - 2197/F105</b></p>	 <p><b>NOXIA - 2197/F105K</b></p>	<p><b>NOXIA - 2197/F105</b> Set placchette incasso con foro chiave con serratura e chiave snodata <i>Sliding door handle set with lock and jointed key</i></p> <p>FINITURE / FINISHES: <b>OLV - OGC - AF - OC - OCS - ONS</b></p> <p><b>NOXIA - 2197/F105K</b> Set placchette incasso con foro chiave con serratura e chiave snodata e frontale <i>Sliding door handle set with lock and jointed key and flush pull hole</i></p> <p>FINITURE / FINISHES: <b>OLV - OGC - AF - OC - OCS - ONS</b></p>

Materiale: ottone - *solid brass*

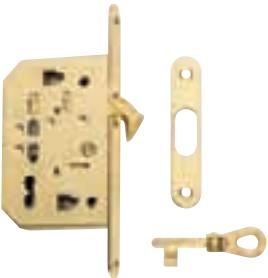
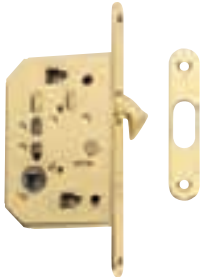
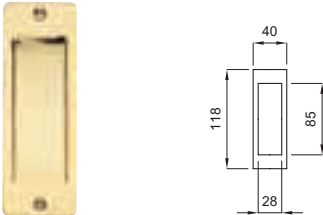
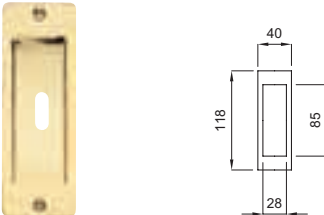
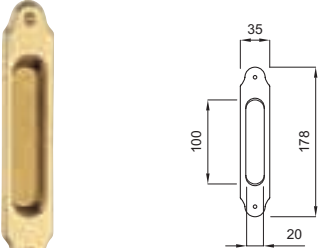
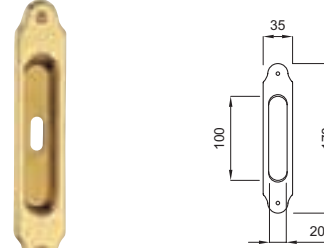
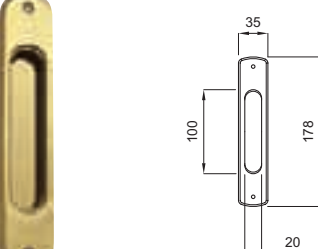
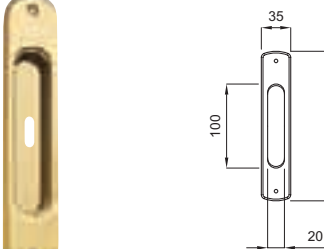
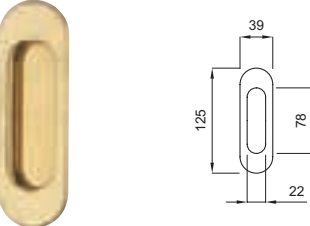
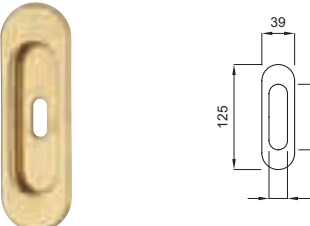
 <p><b>SE105</b></p>	 <p><b>SE106</b></p>	<p><b>SE105</b> Serratura con chiave snodata <i>Lock with jointed key</i></p> <p><b>SE106</b> Serratura con foro quadro 8 mm <i>Lock with 8 mm square hole</i></p> <p><i>FINITURE / FINISHES:</i> <b>OLV - OGC - AF - OC - OCS - ONS</b></p>
 <p><b>RETTANGOLO - 2195</b></p>	 <p><b>RETTANGOLO - 2195/F</b></p>	<p><b>RETTANGOLO - 2195</b> Placchetta incasso <i>Sliding door handle</i></p> <p><b>RETTANGOLO - 2195/F</b> Placchetta incasso con foro chiave <i>Sliding door handle with key hole</i></p> <p><i>FINITURE / FINISHES:</i> <b>OLV - OS - OGC - AF - OGH - OC - OCS - ONS</b></p>
 <p><b>DANIELA - 2190</b></p>	 <p><b>DANIELA - 2190/F</b></p>	<p><b>DANIELA - 2190</b> Placchetta incasso <i>Sliding door handle</i></p> <p><b>DANIELA - 2190/F</b> Placchetta incasso con foro chiave <i>Sliding door handle with key hole</i></p> <p><i>FINITURE / FINISHES:</i> <b>OLV - OGC - AF - OGH - FAN</b></p>
 <p><b>LORENA - 2196</b></p>	 <p><b>LORENA - 2196/F</b></p>	<p><b>LORENA - 2196</b> Placchetta incasso <i>Sliding door handle</i></p> <p><b>LORENA - 2196/F</b> Placchetta incasso con foro chiave <i>Sliding door handle with key hole</i></p> <p><i>FINITURE / FINISHES:</i> <b>OLV - OGC - AF - OC - OCS - ONS</b></p>
 <p><b>NOXIA - 2197</b></p>	 <p><b>NOXIA - 2197/F</b></p>	<p><b>NOXIA - 2197</b> Placchetta incasso coprivite <i>Concealed fix sliding door handle</i></p> <p><b>NOXIA - 2197/F</b> Placchetta incasso coprivite con foro chiave <i>Concealed fix sliding door handle with key hole</i></p> <p><i>FINITURE / FINISHES:</i> <b>OLV - OGC - AF - OC - OCS - ONS</b></p>

# ARTICOLI VARI

## MISCELLANEOUS















ARTICOLI VARI

# NOTTOLINI - TURNS & RELEASES

Materiale: ottone - solid brass



 <p><b>2275</b> Nottolino singolo su rosetta ottone 50 mm <i>Thumb turn on brass rose 50 mm</i></p>	 <p><b>2275 + A</b> Set nottolino su rosetta ottone 50 mm con chiusura tipo "A" <i>Turn &amp; release "A" on brass rose 50 mm</i></p>	 <p><b>2275 + B</b> Set nottolino su rosetta ottone 50 mm con chiusura tipo "B" <i>Turn &amp; release "B" on brass rose 50 mm</i></p>
 <p><b>2286</b> Nottolino singolo su rosetta ottone bombata 50 mm <i>Thumb turn on rounded brass rose 50 mm</i></p>	 <p><b>2286 + A</b> Set nottolino su rosetta ottone bombata 50 mm con chiusura tipo "A" <i>Turn &amp; release "A" on rounded brass rose 50 mm</i></p>	 <p><b>2286 + B</b> Set nottolino su rosetta ottone bombata 50 mm con chiusura tipo "B" <i>Turn &amp; release "B" on rounded brass rose 50 mm</i></p>
 <p><b>2278</b> Nottolino singolo su rosetta ottone 55 mm <i>Thumb turn on brass rose 55 mm</i></p>	 <p><b>2278 + A</b> Set nottolino su rosetta ottone 55 mm con chiusura tipo "A" <i>Turn &amp; release "A" on brass rose 55 mm</i></p>	<p><i>FINITURE / FINISHES</i></p> <p><b>OLV - OS - OGC - AF</b> <b>AB - OBV - FAN - SIL</b> <b>OGH - OC - OCS - ONS</b> <b>PVD - PVD INOX</b></p>
 <p><b>2274 + A</b> Set nottolino su rosetta nylon 45 mm con chiusura tipo "A" <i>Turn &amp; release "A" on nylon rose 45 mm</i></p>	 <p><b>2273 + A</b> Set nottolino su rosetta nylon 50 mm con chiusura tipo "A" <i>Turn &amp; release "A" on nylon rose 50 mm</i></p>	 <p><b>2296 + A</b> Set nottolino su rosetta nylon 52 mm con chiusura tipo "A" <i>Turn &amp; release "A" on nylon rose 52 mm</i></p>
 <p><b>2296G</b> Nottolino singolo su rosetta nylon 52 mm con rilievo <i>Thumb turn on nylon rose 52 mm with relief</i></p>	 <p><b>2296G + A</b> Set nottolino su rosetta nylon 52 mm con rilievo con chiusura tipo "A" <i>Turn &amp; release "A" on nylon rose 52 mm with relief</i></p>	<p><i>FINITURE / FINISHES</i></p> <p><b>OLV - OS - OLS - OC</b> <b>OCS - CCS - ONS - PVD</b> <b>PVD INOX</b></p>



# NOTTOLINI - TURNS & RELEASES











Materiale: ottone - solid brass

 <p><b>2280</b> Nottolino singolo su rosetta ovale 40x60 mm <i>Thumb turn on oval rose 40x60 mm</i></p>	 <p><b>2280 + A</b> Set nottolino su rosetta ovale 40x60 mm con chiusura tipo "A" <i>Turn &amp; release "A" on oval brass rose 50 mm</i></p>	<p><i>FINITURE / FINISHES</i></p> <p><b>OLV - OS - OGC - AF</b> <b>AB - OBV - FAN - SIL</b> <b>OGH - OC - OCS</b></p>
 <p><b>2300</b> Nottolino singolo su rosetta Latina 63x52 mm <i>Thumb turn on Latina rose 63x52 mm</i></p>	 <p><b>2300+A</b> Set nottolino su rosetta Latina 63x52 mm con chiusura tipo "A" <i>Turn &amp; release "A" on Latina rose 63x52 mm</i></p>	<p><i>FINITURE / FINISHES</i></p> <p><b>OLV - OS - OBV - OGH - OGC</b> <b>BSS - FAN - SIL - OC</b> <b>OCS - ONS - PVD - PVD INOX</b></p>
 <p><b>2279</b> Nottolino <i>Thumb turn &amp; release</i></p>		<p><i>FINITURE / FINISHES</i></p> <p><b>OLV - OS - OGC - AF</b> <b>AB - OBV - FAN - SIL</b> <b>OGH - OC - OCS - ONS</b> <b>PVD - PVD INOX</b></p>
 <p><b>2285</b> Nottolino singolo America su rosetta ottone 50 mm <i>America Thumb turn on brass rose 50 mm</i></p>	 <p><b>2285 + A</b> Set nottolino America su rosetta ottone 50 mm con chiusura tipo "A" <i>America Turn &amp; release "A" on brass rose 50 mm</i></p>	 <p><b>2285 + B</b> Set nottolino America su rosetta ottone 50 mm con chiusura tipo "B" <i>America Turn &amp; release "B" on brass rose 50 mm</i></p>
 <p><b>2284</b> Nottolino singolo America su rosetta ottone bombata 50 mm <i>America Thumb turn on rounded brass rose 50 mm</i></p>	 <p><b>2284 + A</b> Set nottolino America su rosetta ottone bombata 50 mm con chiusura tipo "A" <i>America Turn &amp; release "A" on rounded brass rose 50 mm</i></p>	 <p><b>2284 + B</b> Set nottolino America su rosetta ottone bombata 50 mm con chiusura tipo "B" <i>America Turn &amp; release "B" on rounded brass rose 50 mm</i></p>

# NOTTOLINI - TURNS & RELEASES

Materiale: ottone - solid brass











 <p><b>2287</b> Nottolino America singolo su rosetta ottone 55 mm <i>America thumb turn on brass rose 55 mm</i></p>	 <p><b>2287 + A</b> Set nottolino America su rosetta ottone 55 mm con chiusura tipo "A" <i>America turn &amp; release "A" on brass rose 55 mm</i></p>	<p><i>FINITURE / FINISHES</i></p> <p><b>OLV - OS - OGC - AF</b> <b>AB - OBV - FAN - SIL</b> <b>OGH - OC - OCS - ONS</b> <b>PVD - PVD INOX</b></p>
 <p><b>2283</b> Nottolino America singolo su rosetta nylon 45 <i>America thumb turn on nylon rose 45 mm</i></p>	 <p><b>2283 + A</b> Set nottolino America su rosetta nylon 45 mm con chiusura tipo "A" <i>America turn &amp; release "A" on nylon rose 45 mm</i></p>	<p><i>FINITURE / FINISHES</i></p> <p><b>OLV - OS - OGC - AF</b> <b>AB - OBV - FAN - SIL</b> <b>OGH - OC - OCS - ONS</b> <b>PVD - PVD INOX</b></p>
 <p><b>2282</b> Nottolino America singolo su rosetta nylon 50 <i>America thumb turn on nylon rose 50 mm</i></p>	 <p><b>2282 + A</b> Set nottolino America su rosetta nylon 50 mm con chiusura tipo "A" <i>America turn &amp; release "A" on nylon rose 50 mm</i></p>	<p><i>FINITURE / FINISHES</i></p> <p><b>OLV - OS - OGC - AF</b> <b>AB - OBV - FAN - SIL</b> <b>OGH - OC - OCS - ONS</b> <b>PVD - PVD INOX</b></p>
 <p><b>2289</b> Nottolino America singolo su rosetta nylon 52 mm <i>America thumb turn on nylon rose 52 mm</i></p>	 <p><b>2289 + A</b> Set nottolino America su rosetta nylon 52 mm con chiusura tipo "A" <i>America turn &amp; release "A" on nylon rose 52 mm</i></p>	<p><i>FINITURE / FINISHES</i></p> <p><b>OLV - OS - OGC - AF</b> <b>AB - OBV - FAN - SIL</b> <b>OGH - OC - OCS - ONS</b> <b>PVD - PVD INOX</b></p>
 <p><b>2289G</b> Nottolino America singolo su rosetta nylon 52 mm con rilievo <i>America thumb turn on nylon rose 52 mm with relief</i></p>	 <p><b>2289G + A</b> Set nottolino America su rosetta nylon 52 mm con rilievo con chiusura tipo "A" <i>America turn &amp; release "A" on nylon rose 52 mm with relief</i></p>	<p><i>FINITURE / FINISHES</i></p> <p><b>OLV - OS - OLS - OC</b> <b>OCS - CCS - ONS - PVD</b> <b>PVD INOX</b></p>

# NOTTOLINI - TURNS & RELEASES

Materiale: ottone - solid brass

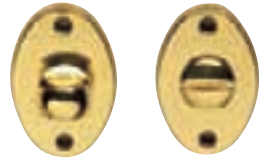

 <p><b>2400</b> Nottolino America singolo su rosetta quadra nylon 50 mm <i>America thumb turn on nylon square rose 50 mm</i></p>	 <p><b>2400 + A</b> Set nottolino America su rosetta quadra nylon 50 mm con chiusura tipo "A" <i>America turn &amp; release "A" on nylon square rose 50 mm</i></p>	<p><i>FINITURE / FINISHES</i></p> <p><b>OLV - OS - OC - OCS</b> <b>ONS - PVD - PVD INOX</b></p>
 <p><b>2401</b> Nottolino Logo singolo su rosetta quadra nylon 50 mm <i>Logo thumb turn on nylon square rose 50 mm</i></p>	 <p><b>2401 + A</b> Set nottolino Logo su rosetta quadra nylon 50 mm con chiusura tipo "A" <i>Logo turn &amp; release "A" on nylon square rose 50 mm</i></p>	<p><i>FINITURE / FINISHES</i></p> <p><b>OLV - OS - OC - OCS</b> <b>ONS - PVD - PVD INOX</b></p>
 <p><b>2281</b> Nottolino America <i>America Thumb turn &amp; release</i></p>		<p><i>FINITURE / FINISHES</i></p> <p><b>OLV - OS - OGC - AF</b> <b>AB - OBV - FAN - SIL</b> <b>OGH - OC - OCS - ONS</b> <b>PVD - PVD INOX</b></p>
 <p><b>2288</b> Nottolino America singolo su rosetta ovale 40x60 mm <i>America thumb turn on oval rose 40x60 mm</i></p>	 <p><b>2288 + A</b> Set nottolino America su rosetta ovale 40x60 mm con chiusura tipo "A" <i>America turn &amp; release "A" on oval rose 40x60 mm</i></p>	<p><i>FINITURE / FINISHES</i></p> <p><b>OLV - OS - OGC - AF</b> <b>AB - OBV - FAN - SIL</b> <b>OGH - OC - OCS</b></p>
 <p><b>2292</b> Nottolino singolo Scandinavia su rosetta ottone 50 mm con fori <i>Scandinavia thumb turn &amp; release on brass rose 50 mm with holes</i></p>	 <p><b>2292 + B</b> Set nottolino Scandinavia su rosetta ottone 50 mm con fori con chiusura tipo "B" <i>Scandinavia turn &amp; release "B" on brass rose 50 mm with holes</i></p>	<p><i>FINITURE / FINISHES</i></p> <p><b>OLV - OS - OGC - AF</b> <b>AB - AB - OBV - FAN</b> <b>SIL - OC - OCS - ONS</b></p>

# SUPPORTI CORRIMANO - HANDRAIL BRACKETS

Materiale: ottone - solid brass



**2263**  
Supporto corrimano  
Handrail bracket



**2258**  
Supporto corrimano testa  
piana  
Handrail bracket plane  
support

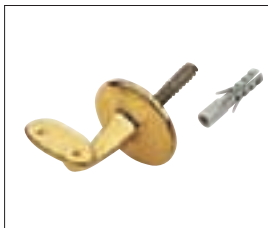

**2258 / 1**  
Supporto corrimano  
testa concava  
Handrail bracket curved  
support

FINITURE / FINISHES  
OLV - OGR - AB  
OC - OCS - ONS

# CATENACCI - BOLTS

Materiale: ottone - solid brass



FINITURE / FINISHES  
OLV - OCS

**2254 / 150**

Catenaccio orizzontale America  
150 mm  
America horizontal bolt  
150 mm

**2254 / 200**

Catenaccio orizzontale America  
200 mm  
America horizontal bolt  
200 mm

**2254 / 250**

Catenaccio orizzontale America  
250 mm  
America horizontal bolt  
250 mm

altre misure disponibili a richiesta ---- other sizes available on request

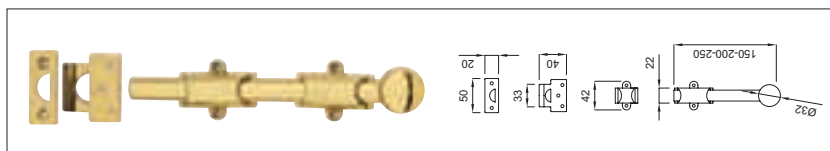

FINITURE / FINISHES  
OLV - OCS

**2256 / 150**

Catenaccio verticale America  
150 mm con incontro A-B  
America vertical bolt 150 mm  
with A-B

**2256 / 200**

Catenaccio verticale America  
200 mm con incontro A-B  
America vertical bolt 200 mm  
with A-B

**2256 / 250**

Catenaccio verticale America  
250 mm con incontro A-B  
America vertical bolt 250 mm  
with A-B

altre misure disponibili a richiesta ---- other sizes available on request



FINITURE / FINISHES  
OL - OLV - AF  
OCS - FAN

**2255 / 150**

Catenaccio orizzontale  
150 mm  
Horizontal bolt 150 mm

**2255 / 200**

Catenaccio orizzontale  
200 mm  
Horizontal bolt 200 mm

**2255 / 250**

Catenaccio orizzontale  
250 mm  
Horizontal bolt 250 mm

# APPENDINI PORTABITI - HAT & COAT HOOKS

Materiale: ottone - solid brass



**2171**  
Portabiti Austria  
Austria hat & coat hook



**2170**  
Appendino Austria  
Austria robe hook

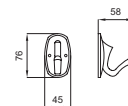
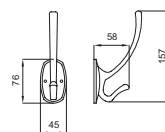

FINITURE / FINISHES  
**OLV - OF**



**2176**  
Portabiti Berlino  
Berlino hat & coat hook



**2175**  
Appendino Berlino 2 ganci  
Berlino double robe hook

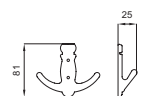
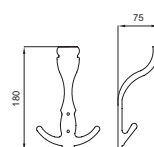

FINITURE / FINISHES  
**OLS - OBS**



**2174**  
Portabiti Londra  
Londra hat & coat hook



**2173**  
Appendino Londra 2 ganci  
Londra double robe hook



**2172**  
Appendino Londra  
Londra robe hook

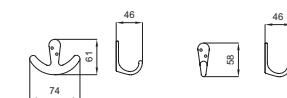
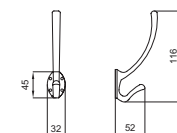

FINITURE / FINISHES  
**OLV - OF**  
**OC - OCS**

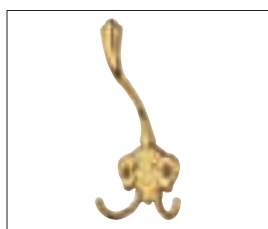

**2180**  
Portabiti Barocco  
Barocco hat & coat hook

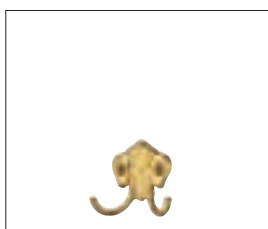

**2179**  
Appendino Barocco 2 ganci  
Barocco double robe hook

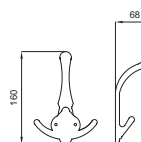

FINITURE / FINISHES  
**OLV - OF**



**2182**  
Portabiti Style  
Style hat & coat hook

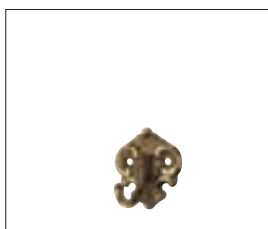

**2181**  
Appendino Style  
Style robe hook

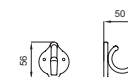
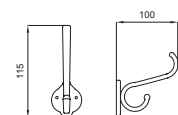

FINITURE / FINISHES  
**OLV - OF**

# BUCALETTERE - LETTER PLATES

Materiale: ottone - solid brass



FINITURE / FINISHES  
**OLV - OGC**

**2210**  
Bucalettere con molla  
*Letter plate spring loaded*



FINITURE / FINISHES  
**OLV - OGC**

**2211**  
Bucalettere a cadenza  
*Gavity flap letter plate*



FINITURE / FINISHES  
**OLV - OGC - OGH**  
**OCS - FAN**

**2212**  
Bucalettere a cadenza  
*Gavity flap letter plate*



FINITURE / FINISHES  
**OLV - OGC - OGH**  
**OCS - FAN**

**2213**  
Bucalettere con molla  
*Letter plate spring loaded*



FINITURE / FINISHES  
**OLV - OGC**

**2214**  
Bucalettere con molla  
*Letter plate spring loaded*



FINITURE / FINISHES  
**OLV - OGC**

**2215**  
Bucalettere con molla  
*Letter plate spring loaded*

## BUCALETTERE - LETTER PLATES

Materiale: ottone - solid brass



FINITURE / FINISHES  
**OLV - OGC**

**2216**

Bucalettere con molla  
*Letter plate spring loaded*



FINITURE / FINISHES  
**OLV - OGC**

**2217**

Bucalettere con molla  
*Letter plate spring loaded*

## ARTICOLI VARI - MISCELLANEOUS

Materiale: ottone - solid brass

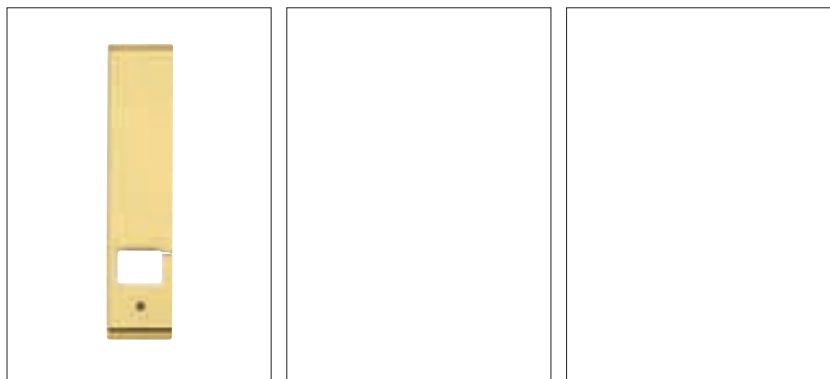

FINITURE / FINISHES  
**OLV**

**2220**

Copriavvolgibile Gamma  
*Gamma coiler cover*



FINITURE / FINISHES  
**OLV - OGC - OCS**

**2160**

Numeri con fori 80 mm  
*Numerals 80 mm face fixing*

# ARTICOLI VARI - MISCELLANEOUS

Materiale: ottone - solid brass



**R017/P**  
Rosetta Cometa 55 mm  
con pulsante  
*Cometa bell push rose 55 mm*



**R008/P**  
Rosetta 50 mm con pulsante  
*Bell push rose 50 mm*



FINITURE / FINISHES  
**OLV - AF - OGC**  
**OC - OCS**



**R014/P**  
Rosetta ovale 40x60 mm  
con pulsante  
*Oval bell push rose 40x60 mm*

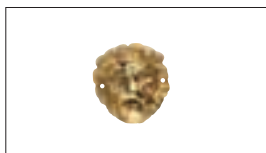

**2153**  
Leoncino con pulsante  
*Bell push*



FINITURE / FINISHES  
**OLV - AF**  
**OGC - OGH**

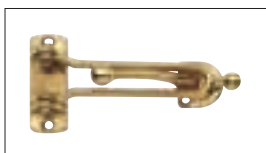

**2251**  
Sicurezza rigida per porte  
*Door safety hook*

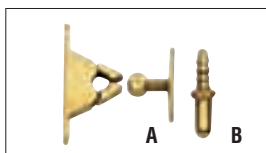

**2320**  
Pinza fermaporta  
incontri A-B  
*Door stop counterside  
with A-B*

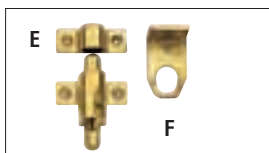

**2321**  
Cricchetto wasistas  
incontri E-F  
*Transom catch with E-F*

FINITURE / FINISHES  
**OL**

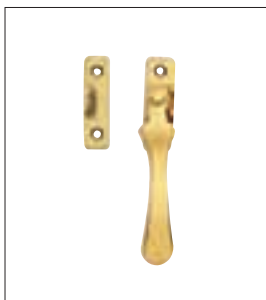

**2260**  
Maniglia blocco a cuneo  
*Wedge casement fastener*

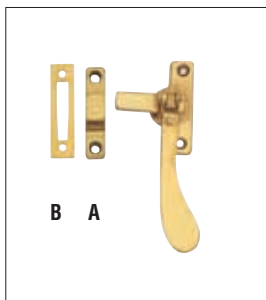

**2262**  
Maniglia blocco reversibile  
*Reversible mortice casement  
fastener*



**2267**  
Fermafinestra  
a ghigliottina 65x40  
*Fitch pattern sash  
fastener 65x40*

FINITURE / FINISHES  
**OLV**

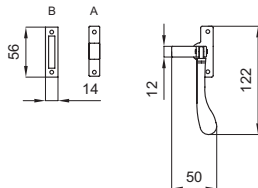
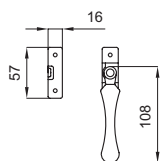



# ARTICOLI VARI - MISCELLANEOUS

Materiale: ottone - solid brass



**2248**  
Chiave ovale  
Door key



FINITURE / FINISHES  
**OLV - OC - OCS**

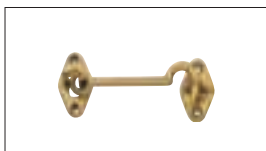

**2269 / 60**  
Fermapersiane 60 mm  
Shutter stay 60 mm

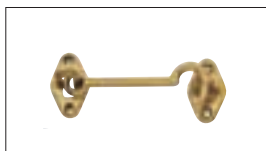

**2269 / 80**  
Fermapersiane 80 mm  
Shutter stay 80 mm



FINITURE / FINISHES  
**OL - OBO**

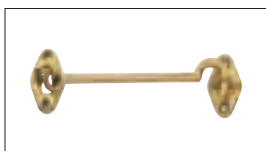

**2269 / 100**  
Fermapersiane 100 mm  
Shutter stay 100 mm

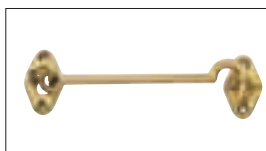

**2269 / 120**  
Fermapersiane 100 mm  
Shutter stay 120 mm



FINITURE / FINISHES  
**OL - OBO**

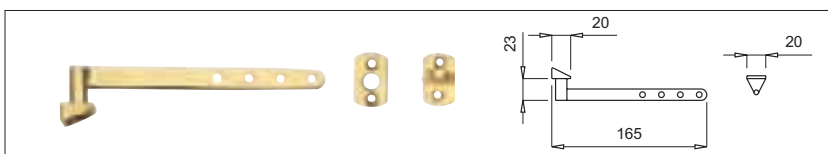

**2253**  
Fermafinestre - Fermapersiane "Block" con 4 posizioni di bloccaggio.  
Basi girevoli, adattabili a finestre e persiane. Lunghezza 165 mm  
Casement and shutter stay with 4 blocking positions.  
Turnable basis, suitable to windows and shutters, 165 mm length

FINITURE / FINISHES  
**OLV - OBO - OC - OCS**



Fermafinestre



Fermapersiane

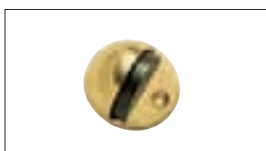

**2264**  
Fermaporta chiocciola  
Ø 45 mm  
Door stop Ø 45 mm



**2265**  
Fermaporta cilindro  
Ø 29x45 mm  
Door stop Ø 29x45 mm

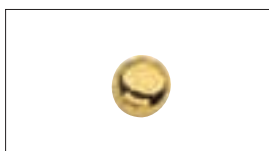

**2330**  
Dado cieco 8 MA  
Blind nut 8 MA

FINITURE / FINISHES  
**OLV - OC - OCS - ONS**

## ARTICOLI VARI - MISCELLANEOUS

Materiale: ottone - solid brass

**martinelli**  
HANDLES WITH CARE

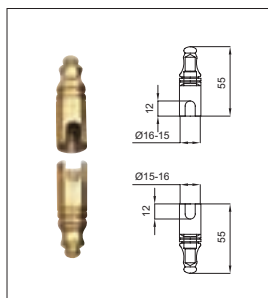

**2313**

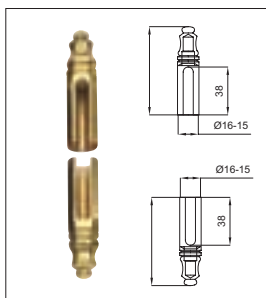

**2313 / 2**

### 2313

Set copricerniere corto con  
piramide A = Ø15 - B = Ø16 mm  
*Short cover hinges set with  
pyramid A = Ø15 - B = Ø16 mm*

### 2313 / 2

Set copricerniere lungo con  
piramide-sole lunghe  
A = Ø15 - B = Ø16 mm  
*Long cover hinges set with  
pyramid-long holes  
A = Ø15 - B = Ø16 mm*

FINITURE / FINISHES

**OLV - OF - OC**

**OCS - ONS**

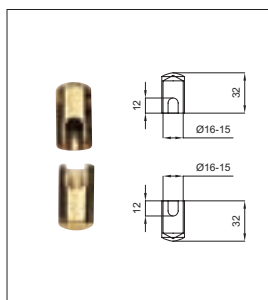

**2314**

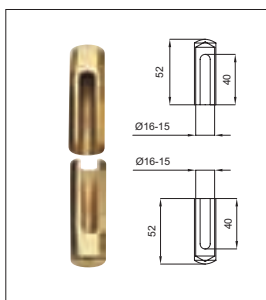

**2314 / 2**

### 2314

Set copricerniere corto  
piatto 16 mm  
*Flat short cover hinges set  
16 mm*

### 2314 / 2

Set copricerniere lungo con  
piramide-sole lunghe  
A = Ø15 - B = Ø16 mm  
*Long cover hinges set with  
pyramid-long holes 16 mm  
A = Ø15 - B = Ø16 mm*

FINITURE / FINISHES

**OLV - OF - OC**

**OCS - ONS**

## ROSETTE - ROSES

Materiale: ottone - solid brass



### R008

Rosetta coprivite 50 mm  
*Concealed fix rose 50 mm*



### R008/B

Rosetta coprivite bombata  
50 mm  
*Rounded concealed fix rose  
50 mm*



### R017

Rosetta coprivite Cometa  
55 mm  
*Cometa concealed fix rose  
55 mm*

FINITURE / FINISHES

**OLV - OS - OGC - AF**

**AB - OGH - FAN - SIL**

**OC - OCS - ONS**

**ORO - PVD - PVD INOX**



### R022

Rosetta coprivite 45 mm  
*Concealed fix rose 45 mm*

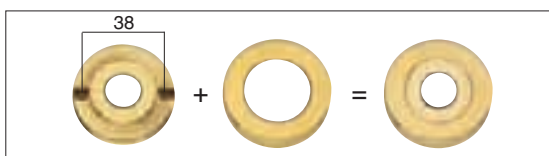

### R008/38

Rosetta coprivite  
50 mm con fori int. 38  
*Concealed fix rose 50 mm  
with 38 mm screw hole centre*

FINITURE / FINISHES

**OLV - OS - OGC - AF**

**AB - OGH - FAN - SIL**

**OC - OCS - ONS**

**ORO - PVD - PVD INOX**

# ROSETTE - ROSES

Materiale: ottone - solid brass

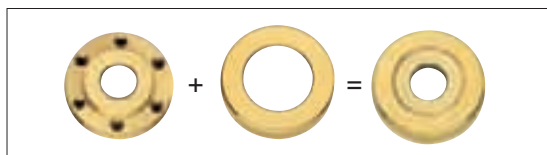

**R033**  
Rosetta coprivite 52 mm 6 fori  
*Concealed fix rose 52 mm  
with 6 holes*

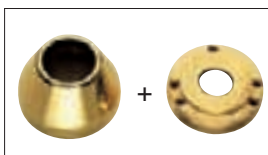

**R035**  
Rosetta coprivite Venice  
50 mm  
*Venice concealed fix rose  
50 mm*

FINITURE / FINISHES  
OLV - OS - OGC - AF  
AB - OGH - FAN - SIL  
OC - OCS - ONS  
ORO - PVD - PVD INOX

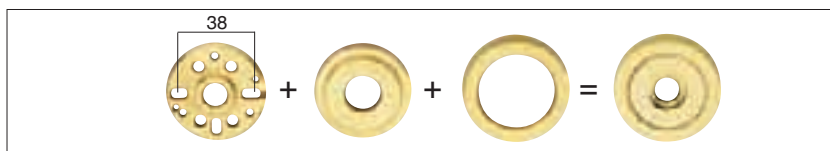

**R044**  
Rosetta coprivite 50 mm in 3 pezzi adattabile  
a serratura scandinava ed a serrature speciali  
*Concealed fix rose 50 mm 3 pieces adaptable  
to scandinavian locks and other special locks*

FINITURE / FINISHES  
OLV - OS - OGC - AF  
AB - OGH - FAN - SIL  
OC - OCS - ONS  
ORO - PVD - PVD INOX

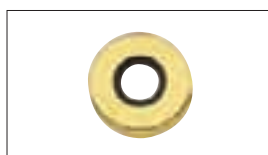

**R018**  
Rosetta 45 mm con base nylon  
fori 22-26  
*Rose 45 mm with nylon base  
22-26 mm holes*



**R025**  
Rosetta 50 mm con base nylon  
fori 22-24-26  
*Rose 50 mm with nylon base  
22-24-26 mm*



**R027**  
Rosetta 52 mm con base nylon  
fori 20-22-25  
*Rose 52 mm with nylon base  
20-22-25 mm holes*

FINITURE / FINISHES  
OLV - OS - OGC - AF  
AB - OGH - FAN - SIL  
OC - OCS - ONS  
PVD - PVD INOX

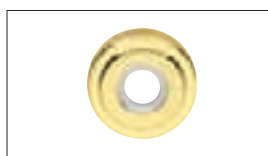

**R027G**  
Rosetta 52 mm con rilievo  
base nylon  
*Rose 52mm with relief nylon  
base*

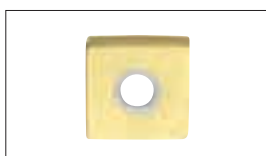

**R041**  
Rosetta quadra 50 mm  
con base nylon  
*Square rose 50 mm  
with nylon base*



**R016**  
Rosetta 30x60 mm con base  
nylon per maniglie con molla  
*Rose 30x60 mm with nylon  
base for handles spring loaded*

FINITURE / FINISHES  
OLV - OS - OGC - AF  
AB - OC - OCS - ONS  
PVD - PVD INOX



**R010**  
Rosetta 45 mm foro 16-20  
*Rose 45 - 16-20 mm hole*



**R011**  
Rosetta 26x67 mm  
*Rose 26x67 mm*

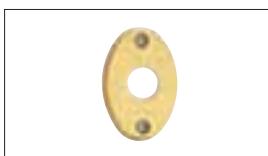

**R014**  
Rosetta 40x60 mm per maniglie  
e pomoli con molla  
*Rose 40x60 mm for handles  
and knobs spring loaded*

FINITURE / FINISHES  
OLV - OS - OGC - AF  
AB - OGH - FAN - SIL  
OC - OCS - ONS

## ROSETTE - ROSES

Materiale: ottone - solid brass



### R015

Rosetta 38x65 mm  
*Rose 38x65 mm*



### R030

Rosetta scandinava 50 mm  
*Scandinavian standard rose 50 mm*



### RODK - RODK/Q

Rosetta per DK 30x65 mm  
*Rose 30x65 for DK mechanism*

FINITURE / FINISHES

OLV - OS - OGC - AF  
AB - OGH - FAN - SIL  
OC - OCS - ONS  
PVD - PVD INOX



### R042

Rosetta Latina 63x52 mm  
*Latina rose 63x52 mm*

FINITURE / FINISHES

OLV - OS - OGC - OBV  
OGH - BSS - OC - OCS  
FAN - SIL - PVD - PVD INOX

## BOCCHETTE DI SICUREZZA - SECURITY ESCUTCHEONS

Materiale: ottone - solid brass

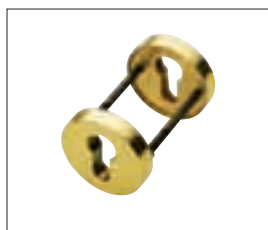

### B046

Set bocchette di sicurezza 52mm - foro Yale  
interasse 38 mm viti passanti 5MA, con base di sicurezza in acciaio  
*Security escutcheons set 52mm - Euro profile hole*  
*38 mm distance between centre 5MA through fixing screws*  
*with internal security steel base*

FINITURE / FINISHES

OLV - OC - OCS  
PVD - PVD INOX

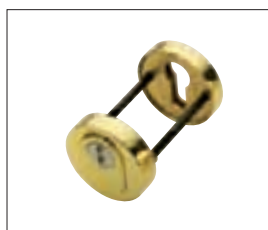

### B047

Set bocchette di sicurezza 52 mm - foro Yale e copricilindro  
interasse 38 mm viti passanti 5MA, con base di sicurezza in acciaio  
*Security escutcheons set 52 mm - Euro profile hole and cover cylinder*  
*38 mm distance between centre 5MA through fixing screws*  
*with internal security steel base*

FINITURE / FINISHES

OLV - OC - OCS  
PVD - PVD INOX

# BOCCHETTE - ESCUTCHEONS

Materiale: ottone - solid brass

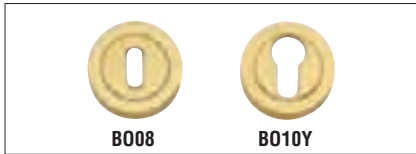

**B008 - B010Y**  
Bocchetta coprivite 50 mm  
Concealed fix escutcheon 50 mm

B008 = Patent - standard profile  
B010Y = Yale - Euro profile

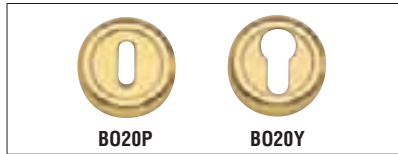

**B020**  
Bocchetta coprivite bombata 50 mm  
Concealed fix rounded escutcheon 50mm

B020P = Patent - standard profile  
B020Y = Yale - Euro profile

FINITURE / FINISHES  
OLV - OS - OGC - AF  
AB - OGH - FAN - SIL  
OC - OCS - ONS  
ORO - PVD - PVD INOX



**B013**  
Bocchetta coprivite Cometa 55mm  
Cometa concealed fix escutcheon 55mm  
B013B = BB - standard profile  
B013P = Patent - standard profile  
B013Y = Yale - Euro profile



**B019**  
Bocchetta coprivite 45mm  
Concealed fix escutcheon 45 mm  
Patent - Standard profile

FINITURE / FINISHES  
OLV - OS - OGC - AF  
AB - OGH - FAN - SIL  
OC - OCS - ONS  
ORO - PVD - PVD INOX

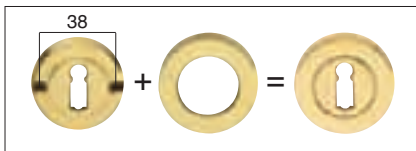

**B008/38**  
Bocchetta coprivite 50mm con fori int.38  
Concealed fix escutcheon 50mm with 38mm  
screw holes centre

foro BB - standard profile

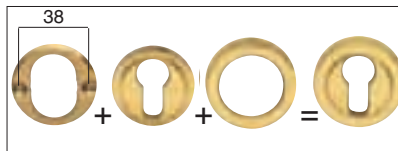

**B008Y/38**  
Bocchetta coprivite 50 mm con fori int.38  
Concealed fix escutcheon 50 mm with 38 mm  
screw holes centre

foro Yale - Euro profile

FINITURE / FINISHES  
OLV - OS - OGC - AF  
AB - OGH - FAN - SIL  
OC - OCS - ONS  
ORO - PVD - PVD INOX

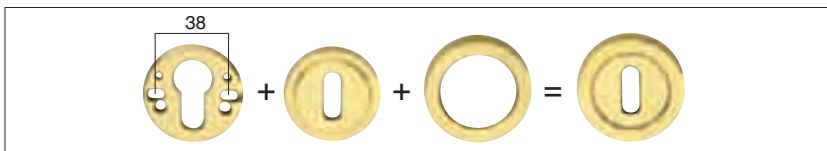

**B044P**  
Bocchetta coprivite 50 mm in 3 pezzi adattabile  
a serratura scandinava ed a serrature speciali  
Concealed fix escutcheon 50 mm 3 pieces adaptable  
to scandinavian locks and other special locks

B044P = Patent - standard profile

FINITURE / FINISHES  
OLV - OS - OGC - AF  
AB - OGH - FAN - SIL  
OC - OCS - ONS  
ORO - PVD - PVD INOX

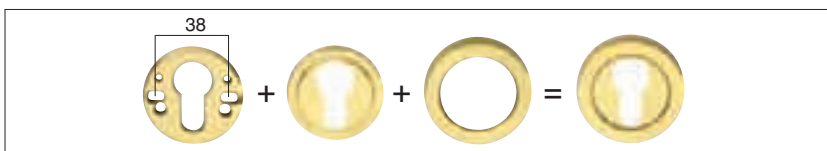

**B044Y**  
Bocchetta coprivite 50 mm in 3 pezzi adattabile  
a serratura scandinava ed a serrature speciali  
Concealed fix escutcheon 50 mm 3 pieces adaptable  
to scandinavian locks and other special locks

B044Y = Yale - Euro profile

FINITURE / FINISHES  
OLV - OS - OGC - AF  
AB - OGH - FAN - SIL  
OC - OCS - ONS  
ORO - PVD - PVD INOX

# BOCCHETTE - ESCUTCHEONS

Materiale: ottone - solid brass

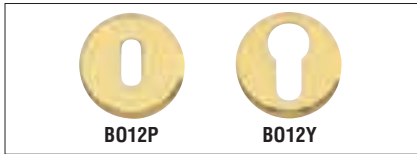

**B012P**

**B012Y**

## B012

Bocchetta 45 mm con base nylon  
Escutcheon 45 mm with nylon base

B012P = Patent - standard profile  
B012Y = Yale - Euro profile

### FINITURE / FINISHES

OLV - OS - OGC - AF  
AB - OGH - FAN - SIL  
OC - OCS - ONS  
PVD - PVD INOX

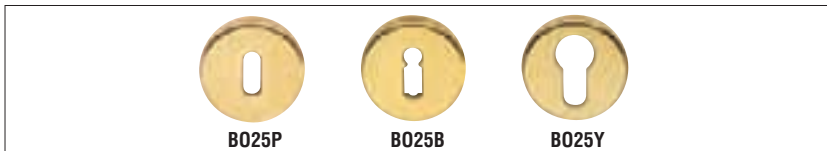

**B025P**

**B025B**

**B025Y**

## B025

Bocchetta 50 mm con base nylon  
Escutcheon 50 mm with nylon base

B025P = foro Patent - Standard profile  
B025B = foro BB - Standard profile  
B025Y = foro Yale - Euro profile

B025PB = foro Patent con bussole  
Standard profile with bushes  
B025BB = foro BB con bussole  
Standard profile with bushes  
B025YB = foro Yale con bussole  
Euro profile with bushes

### FINITURE / FINISHES

OLV - OS - OGC - AF  
AB - OGH - FAN - SIL  
OC - OCS - ONS  
PVD - PVD INOX



**B027P**

**B027B**

**B027Y**

## B027

Bocchetta 52 mm con base nylon  
Escutcheon 52 mm with nylon base

B027P = foro Patent - Standard profile  
B027B = foro BB - Standard profile  
B027Y = foro Yale - Euro profile

B027PB = foro Patent con bussole  
Standard profile with bushes  
B027BB = foro BB con bussole  
Standard profile with bushes  
B027YB = foro Yale con bussole  
Euro profile with bushes

### FINITURE / FINISHES

OLV - OS - OGC - AF  
AB - OGH - FAN - SIL  
OC - OCS - ONS  
PVD - PVD INOX

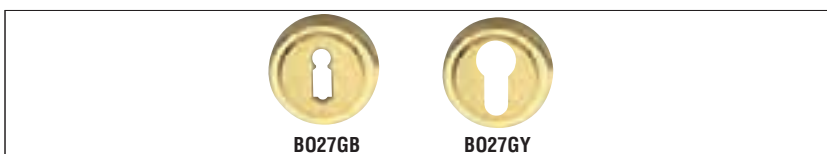

**B027GB**

**B027GY**

## B027G

Bocchetta 52 mm con rilievo base nylon  
Escutcheon 52 mm with relief nylon base

B027GB = foro BB - Standard profile  
B027GY = foro Yale - Euro profile

B027GBB = foro BB con bussole  
Standard profile with bushes  
B027GYB = foro Yale con bussole  
Euro profile with bushes

### FINITURE / FINISHES

OLV - OS - OLS - OC  
OCS - ONS  
PVD - PVD INOX



## B015

Bocchetta doppia mappa  
45 mm  
Escutcheon special key hole  
45 mm



## B017

Bocchetta doppia mappa  
52 mm  
Escutcheon special key hole  
52 mm



## B035

Bocchetta cieca 50 mm  
base nylon  
Blind escutcheon 50 mm  
with nylon base

### FINITURE / FINISHES

OLV - OS - OGC - AF  
AB - FAN - SIL - OC  
OCS - ONS - PVD - PVD INOX

# BOCCHETTE - ESCUTCHEONS

Materiale: ottone - solid brass

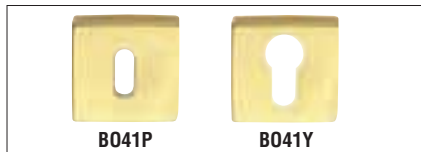

**B041P**

**B041Y**

## B041

Bocchetta quadra 50 mm con base nylon  
*Square escutcheon 50 mm with nylon base*

B041P = Patent - standard profile

B041Y = Yale - Euro profile

FINITURE / FINISHES

OLV - OS - OC  
OCS - ONS - PVD - PVD INOX



**B016P**

**B016Y**

## B016

Bocchetta 30x60 mm con base nylon  
*Escutcheon 30x60 mm with nylon base*

B016P = Patent - standard profile

B016Y = Yale - Euro profile



## B003

Bocchetta 40 mm  
*Escutcheon 40 mm*

FINITURE / FINISHES

OLV - OS - OGC - AF  
AB - OGH - FAN - SIL  
OC - OCS - ONS



**B006B**

**B009Y**

## B006 - B009Y

Bocchetta 45 mm  
*Escutcheon 45 mm*

B006B = BB - standard profile

B009Y = Yale - Euro profile

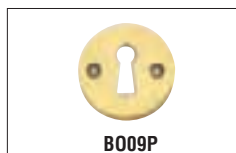

**B009P**

## B009P

Bocchetta 40 mm  
*Escutcheon 40 mm*

B009P = Patent - standard profile

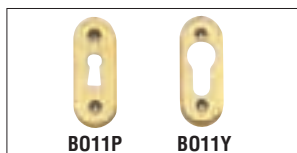

**B011P**

**B011Y**

## B011

Bocchetta 26x67 mm  
*Escutcheon 26x67 mm*

B011P = Patent - standard profile

B011Y = Yale - Euro profile

FINITURE / FINISHES

OLV - OS - OGC - AF  
AB - OGH - FAN - SIL  
OC - OCS - ONS



**B014**

**B014Y**

## B014

Bocchetta 40x60 mm  
*Escutcheon 40x60 mm*

B014P = Patent - standard profile

B014Y = Yale - Euro profile

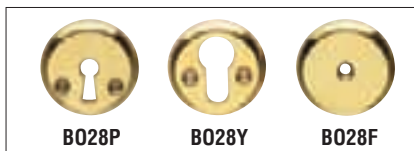

**B028P**

**B028Y**

**B028F**

## B028

Bocchetta scandinava 50 mm  
*Scandinavian standard escutcheon 50 mm*

B028P Patent - standard profile

B028Y Yale - Euro profile

B028F foro centrale - central hole

FINITURE / FINISHES

OLV - OS - OGC - AF  
AB - OGH - FAN - SIL  
OC - OCS - ONS

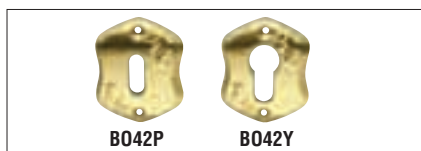

**B042P**

**B042Y**

## B042

Bocchetta Latina 63x52 mm  
*Latina escutcheon 63x52 mm*

B042P = Patent - standard profile

B042Y = Yale - Euro profile

FINITURE / FINISHES

OLV - OS - OGC - OBV  
OGH - BSS - OC - OCS  
FAN - SIL - PVD - PVD INOX

PLACCHE PER MANIGLIE  
PLATES FOR DOOR HANDLES

Materiale: ottone - solid brass

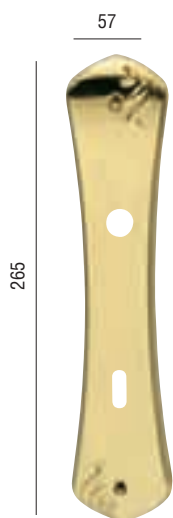

PL820 Latina

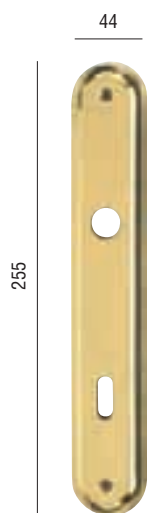

PL200 Cometa

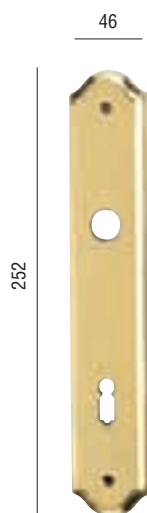

PL570 Classic



PL310 Noxia

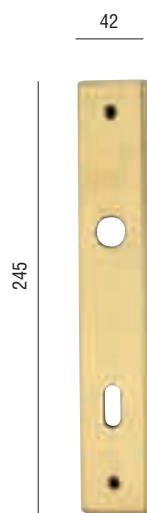

PL169 Quadra

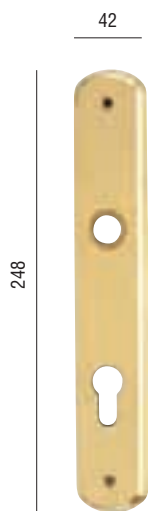

PL250 Lorena

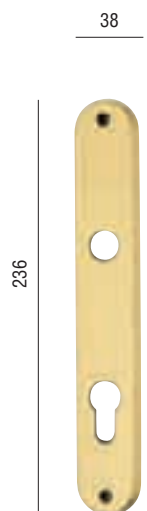

PL279 Sabina

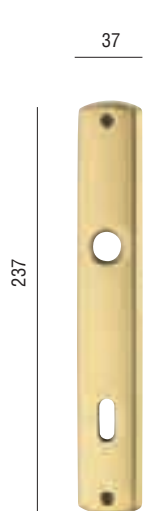

PL590 Arcadia

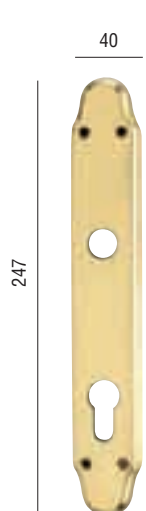

PL390 Daniela

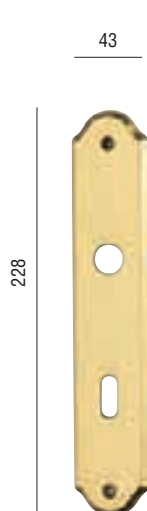

PL460 Vienna

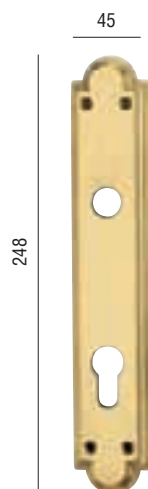

PL477 Luna



PL449 Paperino

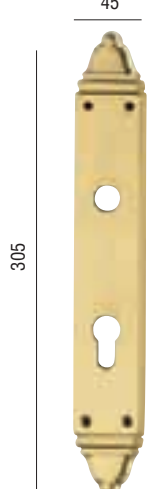

PL472 Doria

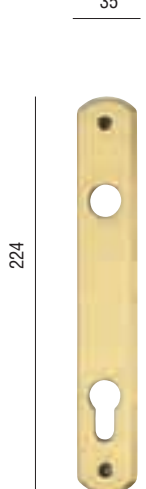

PL349 Belgio

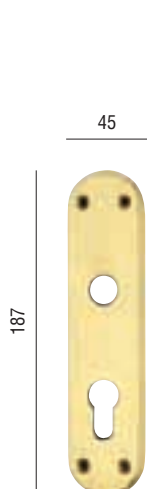

PLM122 Rosy



PLACCHE PER CREMONESI  
 PLATES FOR WINDOW HANDLES

Materiale: ottone - solid brass

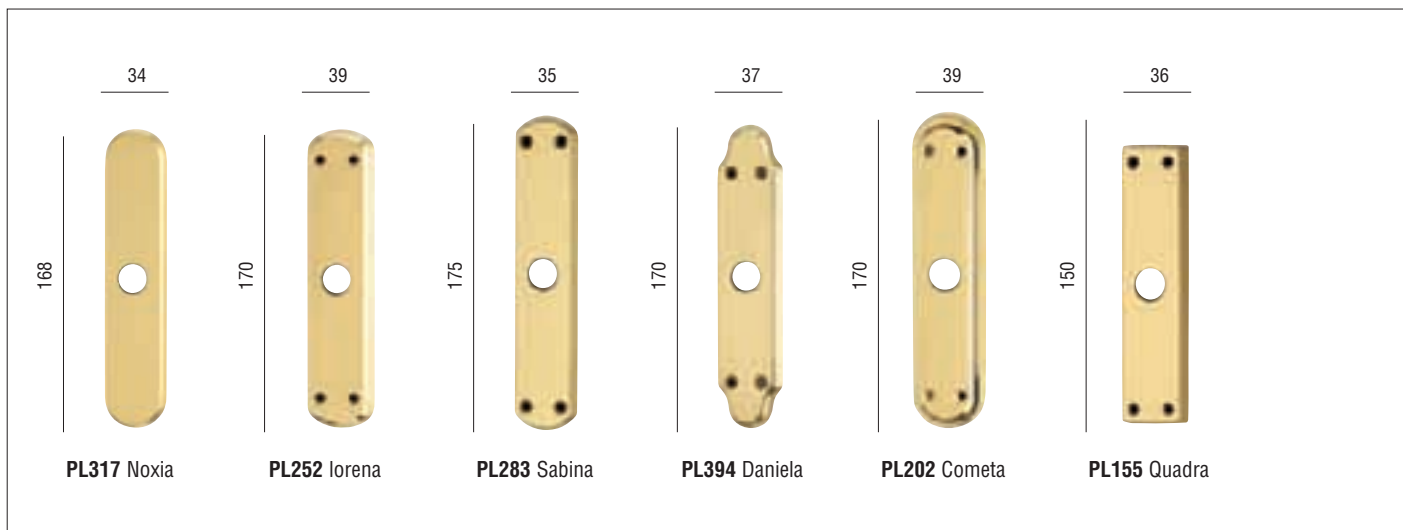

PLACCHE CIECHE / SPINGIPORTA  
 BLIND PLATES / FINGER PLATES





**ESP01/M**

Espositore Martinelli da parete  
mm 500 x 1.000 h  
*Martinelli wall display  
mm 500 x 1.000 h*



**possibilità di montaggio  
a più moduli**  
*possibility of placing more  
units side by side*



**ESP02/M**

Espositore Martinelli da parete  
mm 500 x 2.000 h  
*Martinelli wall display  
mm 500 x 2.000 h*



**possibilità di montaggio  
a più moduli**  
*possibility of placing more  
units side by side*



**ESP06/M**

Espositore Martinelli fisso 3 lati  
mm 500 x 500 x 2.000 h  
*Martinelli 3 sides display  
mm 500 x 500 x 2.000 h*



**ESP05/M**

Espositore Martinelli da banco  
mm 215 x 200 x 325 h  
*Martinelli desk display  
mm 215 x 200 x 325 h*





**ARON#Y1619014**  
Rondella nylon  
Ø16 - Ø19 x mm 1 marrone  
*Brown nylon*  
Ø16 - Ø19 x 1 mm washer



**ARON#Y1619011**  
Rondella nylon  
Ø16 - Ø19 x mm 1 bianco  
*White nylon*  
Ø16 - Ø19 x 1 mm washer



**ARON#Y1621011**  
Rondella nylon  
Ø16 - Ø21 x mm 1 bianco  
*White nylon*  
Ø16 - Ø21 x 1 mm washer



**ARON#Y1621014**  
Rondella nylon  
Ø16 - Ø21 x mm 1 marrone  
*Brown nylon*  
Ø16 - Ø21 x 1 mm washer



**ARON#A6220X4**  
Rondella acciaio ondulata  
Ø16,2 x Ø20 x mm 0,4  
*Wavy steel*  
Ø16,2 x Ø20 x 0,4 mm washer



**ARON#F6220X8**  
Rondella ferro  
Ø16,2 - Ø20 x mm 0,8  
*Iron* Ø16,2 - Ø20 x 0,8 mm  
washer



**ARON#F6220X4**  
Rondella ferro  
Ø16,2 - Ø20 x mm 0,4  
*Iron* Ø16,2 - Ø20 x 0,4 mm  
washer



**AGRI#05005**  
Grani INOX promoblock  
M5 X5 mm  
*Steel* M5 x 5 mm promoblock  
grub-screws



**AGRA#05006**  
Grani M5 x 6 mm con esagono  
punta conica  
*M5 x 6 mm conic point grub*  
screws



**AGRA#05008**  
Grani M5 x 8 mm con esagono  
punta conica  
*M5 x 8 mm conic point grub*  
screws



**AGRA#05005**  
Grani M5 x 5 mm con esagono  
punta conica  
*M5 x 5 mm conic point grub*  
screws



**AGRI#05006**  
Grani INOX promoblock  
M5 X 6 mm  
*Steel* M5 x 6 mm promoblock  
grub-screws



**ASEE#15**  
Seeger Ø15 DIN 471  
*Ø15 Circlip DIN 471*



**AFEM#...**  
Fermo molla mm 1  
(disponibile in diversi spessori)  
*Spring retainer 1 mm*  
(available with different thickness)



**AMOL#2GR**  
Molla mm 2  
*2 mm spring*



**AMOL#3GR**  
Molla mm 3  
*3 mm spring*

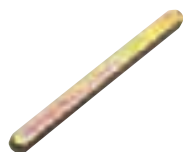

**AFER#80100**  
Ferro quadro l 8 mm 100  
zincato (disponibile varie misure)  
*Square zink 8 x 100 mm*  
spindle (available in various sizes)



**AFER#801052**  
Ferro quadro l 8 mm 105  
2 tagli + 2 fres. zincato  
(disponibile varie misure)  
*Square zink 8 x 105 mm*  
spindle with 2 milled slots  
(available in various sizes)



**AFER#80070N**  
Ferro quadro l 8 mm 70  
c/niplex M12  
*Square 8 x 70 mm spindle*  
niples thread M12



**AFER#80110N**  
Ferro quadro l 8 mm 110  
c/niplex M14  
*Square 8 x 110 mm spindle*  
niples thread M14



**AFER#80065E**  
Ferro quadro l 8 mm 65  
a espansione zincato  
*Expansion zink square*  
8 X 65 mm spindle with nut



**AFER#800703**  
Ferro per wechsel l 8 mm 70  
c/rondella  
*Square 8 x 70 mm spindle*  
with washer for entry door sets



**ARID#F**  
Riduzione ferro l 7 a l 8  
30 mm (disponibili diverse misure)  
*Iron squared 7/8 mm x 30 mm*  
sleeve (available in different sizes)



**ARID#Y**  
Riduzione nylon l 7 a l 8  
mm 28 (disponibili diverse misure)  
*Nylon squared 7/8 mm X 28 mm*  
sleeve (available in different sizes)



**APAR#45**  
Piastrina per pomoli fissi fil. M8  
*Fixing base with M8 threaded bolt*



**APAR#47**  
Piastrina per pomoli fissi fil. M10  
*Fixing base with M10 threaded bolt*



**APAR#44**  
Piastrina per pomoli e maniglie  
fisse I 8  
*Fixing base with 8 mm square spindle*



**ACHI#A2**  
Chiave 2,5 mm esagonale  
ferro zincata  
*Allen key 2,5 mm*



**SDAD#8ETO**  
Dado M8 esagonale tornito  
grezzo  
*Hexagonal M8 screw nut machined raw*



**SDAD#8ECR**  
Dado M8 esagonale cromo  
*Hexagonal M8 screw nut chrome plated*



**APAR#55**  
Riduzione quadra M14/M8  
per pomoli  
*Squared M14/M8 threaded sleeve for knobs*



**APAR#57**  
Riduzione esagonale  
M14/M8 manettoni  
*Hexagonal M14/M8 sleeve for pull handles*

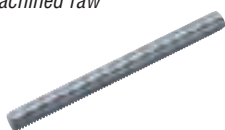

**ATRO#...**  
Troncane zincato (disponibile in  
varie misure M6/M8/M10)  
*Zink threaded bolt (available with different thread: M6/M8/M10)*



**SET 0121**  
Set 2 accessori per fissaggio  
maniglioni singoli  
*Set of 2 accessories for single pull handles*



**SET 0122**  
Set 2 tronconi M10 x 90,5  
per fissaggio maniglioni senza  
rosette, accoppiati  
*Set of 2 M10 x 90,5 fixing threaded screws for back to back pull handles without roses*



**SET 0123**  
Set 2 tronconi M10 x 99,5  
per fissaggio maniglioni con  
rosette, accoppiati  
*Set of 2 M10 x 99,5 fixing threaded screws for back to back pull handles on roses*



**SET0046**  
Set 4 viti 3,5 x 20 testa croce  
bronz.  
*Set of 4 cross slotted wood screws 3,5 x 20 mm bronze*



**SET00159**  
Set 4 viti M4 x 60 c/canaline  
+ 4 bussole M4 x 20 cacciavite  
*Set of 4 single slot screws M4 x 60 mm with cuts + 4 bushes M4 x 20 mm*



**SET00187**  
Set 2 viti M4 x 45 + 2 bussole  
M4 x 20 testa cacciavite  
lucide  
*Set of 2 single slot screws M4 x 45 mm + 2 bushes M4 x 20 mm*



**SET0103**  
Set 8 viti 3,5 x 25 testa croce  
lucide  
*Set of 8 cross slotted wood screws 3,5 x 25 mm*



**SET0091**  
Set 4 viti 2,5 x 20 zincate  
*Set of 2 zink 2,5 x 20 mm wood screws*



**SET0012**  
Set 4 viti 3,5 x 25 testa croce  
lucide  
*Set of 4 cross slotted wood screws 3,5 x 25 mm*



**SET0025**  
Set 4 viti 3,5 x 25 testa croce  
lucide + 2 grani M5 x 6 + 1 chiave  
mm 2,5  
*Set of 4 cross slotted wood screws 3,5 x 25 + 2 grub-screws M 5x6 + 1 allen key 2,5 mm*



**SET0079**  
Set 2 grani M5 x 8 + 1 chiave  
mm 2,5  
*Set of 2 M5 x 8 mm grub-screws+1 allen key 2,5 mm*



**SET0022**  
Set 1 grano M5 x 6 + 1 chiave  
mm 2,5  
*Set of 1 M5 x 6 mm grub-screw + 1 allen key 2,5 mm*

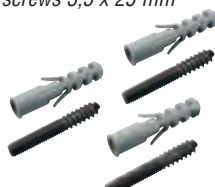







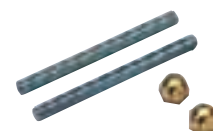



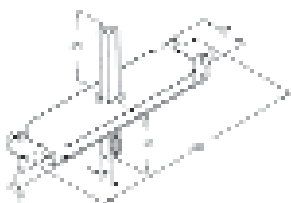
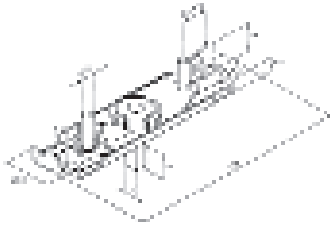
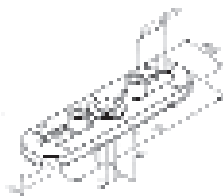
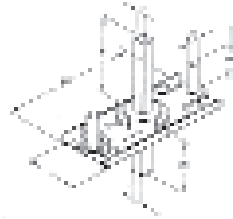
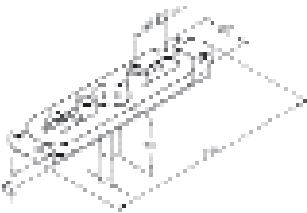
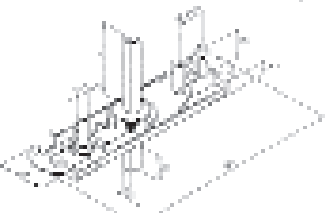

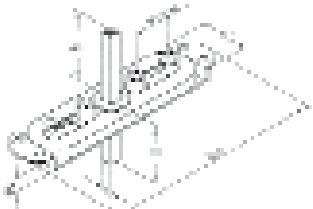
**SET0063**  
Set 3 viti connessione  
M8 x mm 60 + 3 tasselli NY.T12  
*Set of 3 fish-screws M8x60mm + 3 NY.T12 dowels*

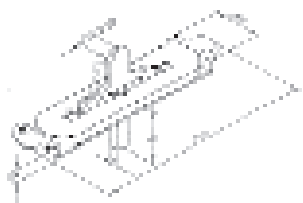

**SET0029**  
Set 2 tronconi M10 x mm88  
+ 2 tasselli NY.T14 + 2 buss.  
Ø14-M10  
*Set of 2 fish-screws M10 x88mm + 2 NY.T14 dowels + 2 bushes Ø14-M10*

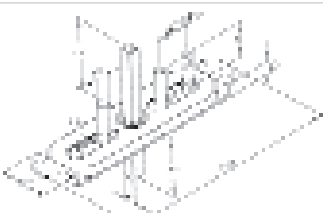
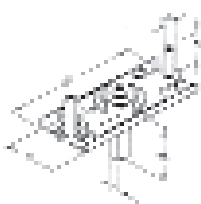

**ASTD#06070ZI**  
Set 2 tronconi M6 x 70mm  
zincati + 2 dadi ottone  
ciechi M6  
*Set of 2 zink M6 x 70mm bolts + 2 M6 blind screw nuts*

MECCANISMI TIPO "A" PER CREMONESE - MECHANISM "A" FOR WINDOW HANDLE		MECCANISMI TIPO "B" PER CREMONESE - MECHANISM "B" FOR WINDOW HANDLE	
 meccanismo per martellina con ferro 7x45 mm <b>AMEC28</b>	 meccanismo MP <b>AMEC30</b>	 meccanismo gratz tubetti <b>AMEC03</b>	 meccanismo MP con ferro 7x45 mm <b>AMEC55</b>
 meccanismo gratz tubetti <b>AMEC11</b>	 meccanismo MP con ferro 7x45 mm <b>AMEC53</b>	 meccanismo gratz tubetti con ferro 7x45 mm <b>AMEC16</b>	 meccanismo gola lupo laterale <b>AMEC39</b>
 meccanismo gratz tubetti con ferro 7x45 mm <b>AMEC25</b>	 meccanismo gola lupo laterale <b>AMEC27</b>	 meccanismo gratz perni <b>AMEC15</b>	 meccanismo gola lupo centrale <b>AMEC38</b>
 meccanismo gratz perni <b>AMEC23</b>	 meccanismo gola lupo centrale <b>AMEC26</b>	 meccanismo gratz perni con ferro 7x45 mm <b>AMEC54</b>	 meccanismo DK ferro 7x40 mm <b>AMEC10</b>
 meccanismo gratz perni con ferro 7x45 mm <b>AMEC52</b>		 meccanismo MP <b>AMEC04</b>	
 Meccanismo DK con tubetti ferro 7X40 mm <b>AMEC 09</b>	 Meccanismo DK ferro 7x40 mm <b>AMEC 10</b>	 Meccanismo DK nylon <b>AMEC 09</b>	



